

Monitoring Relays 1-Phase True RMS AC/DC Over or Under Current Types DIB01, PIB01



DIB01



PIB01

- TRMS AC/DC over or under current monitoring relay
- Current measuring through internal shunt
- Selection of measuring range by DIP-switches
- Measuring ranges from 0.1 mA to 10 A AC/DC
- Adjustable current on relative scale
- Adjustable hysteresis on relative scale
- Adjustable delay function (0.1 to 30 s)
- Programmable latching or inhibit at set level
- Output: 8 A SPDT relay N.D. or N.E. selectable
- For mounting on DIN-rail in accordance with DIN/EN 50 022 (DIB01) or plug-in module (PIB01)
- 22.5 mm Euronorm housing (DIB01) or 36 mm plug-in module (PIB01)
- LED indication for relay, alarm and power supply ON
- Galvanically separated power supply

Product Description

DIB01 and PIB01 are precise TRMS AC/DC over or under current (selectable by DIP-switch) monitoring relays. Direct measuring or through current transformer. Owing to the built-in latch function, the ON-position of the relay output can be maintained. Inhibit function

can be used to avoid relay operation when not desired (maintenance, transitions). The LED's indicate the state of the alarm and the output relay. Through the built-in shunt it is possible to monitor loads up to 10 A AC/DC.

Ordering Key

DIB 01 C B23 5A



Type Selection

Mounting	Output	Measuring range	Supply: 24 to 48 VAC/DC	Supply: 115/230 VAC
DIN-rail	SPDT	0.1 to 5 mA AC/DC	DIB 01 C D48 5mA	DIB 01 C B23 5mA
		1 to 50 mA AC/DC	DIB 01 C D48 50mA	DIB 01 C B23 50mA
		10 to 500 mA AC/DC	DIB 01 C D48 500mA	DIB 01 C B23 500mA
		0.1 to 5 A AC/DC	DIB 01 C D48 5A	DIB 01 C B23 5A
		1 to 10 A AC/DC	DIB 01 C D48 10A	DIB 01 C B23 10A
Plug-in	SPDT	0.1 to 5 mA AC/DC	PIB 01 C D48 5mA	PIB 01 C B23 5mA
		1 to 50 mA AC/DC	PIB 01 C D48 50mA	PIB 01 C B23 50mA
		10 to 500 mA AC/DC	PIB 01 C D48 500mA	PIB 01 C B23 500mA
		0.1 to 5 A AC/DC	PIB 01 C D48 5A	PIB 01 C B23 5A
		1 to 10 A AC/DC	PIB 01 C D48 10A	PIB 01 C B23 10A

Input Specifications

Input (current level)	Terminals Y1, Y2 Terminals 5, 7	Internal resist.	Max. curr.	Measuring ranges (cont.)	Internal resist.	Max. curr.				
DIB01				..500MA: 10 to 100 mA AC/DC 20 to 200 mA AC/DC 50 to 500 mA AC/DC Max. current for 1 s	0.5 Ω	700 mA				
PIB01					0.5 Ω	700 mA				
Measuring ranges Direct Selectable by DIP-switch	Internal resist.	Max. curr.	..5MA: 0.1 to 1 mA AC/DC 0.2 to 2 mA AC/DC 0.5 to 5 mA AC/DC Max. current for 1 s	..5A: 0.1 to 1 A AC/DC 0.2 to 2 A AC/DC 0.5 to 5 A AC/DC Max. current for 1 s	0.5 Ω	100 mA				
					50 Ω	50 mA	0.05 Ω	6 A		
					50 Ω	50 mA	0.05 Ω	6 A		
					50 Ω	50 mA	0.05 Ω	6 A		
					5 Ω	150 mA		15 A		
					5 Ω	150 mA		15 A		
					5 Ω	150 mA		15 A		
					5 Ω	500 mA		50 A		
								..10A: 1 to 10 A AC/DC Max. current for 1 s	3 mΩ	11 A
										50 A

Input Specifications (cont.)

Measuring ranges (cont.)

Standard CT (examples)	AAC _{rms}	Max. curr.
TADK2 50 A/5 A	5 to 50 A	60 A
CTD1 150 A/5 A	15 to 150 A	180 A
CTD4 400 A/5 A	40 to 400 A	480 A
TAD12 1000 A/5 A	100 to 1000 A	1200 A
TACO200 6000 A/5 A	600 to 6000 A	7200 A

Note:

The input voltage cannot raise over 300 VAC/DC with respect to ground (PIB01 only)

Contact input

DIB01	Terminals Z1, Y1
PIB01	Terminals 8, 9
Disabled	> 10 kΩ
Enabled	< 500 Ω
Latch disable	> 500 ms

Output Specifications

Output	SPDT relay
Rated insulation voltage	250 VAC
Contact ratings (AgSnO₂)	μ
Resistive loads AC 1	8 A @ 250 VAC
DC 12	5 A @ 24 VDC
Small inductive loads AC 15	2.5 A @ 250 VAC
DC 13	2.5 A @ 24 VDC
Mechanical life	≥ 30 x 10 ⁶ operations
Electrical life	≥ 10 ⁵ operations (at 8 A, 250 V, cos φ = 1)
Operating frequency	≤ 7200 operations/h
Dielectric strength	
Dielectric voltage	≥ 2 kVAC (rms)
Rated impulse withstand volt.	4 kV (1.2/50 μs)

Supply Specifications

Power supply

Rated operational voltage through terminals:

A1, A2 or A3, A2 (DIB01)
2, 10 or 11, 10 (PIB01)

D48:

24 to 48 VAC/DC ± 15%
45 to 65 Hz, insulated

B23:

115/230 VAC ± 15%
45 to 65 Hz, insulated

Dielectric voltage

Supply to input
Supply to output
Input to output

DC supply

2 kV
4 kV
4 kV

AC supply

4 kV
4 kV

Rated operational power

AC
DC

4 VA
0.8 W

General Specifications

Power ON delay	1 s ± 0.5 s or 6 s ± 0.5 s
Reaction time	(input signal variation from -20% to +20% or from +20% to -20% of set value)
Alarm ON delay	< 100 ms
Alarm OFF delay	< 100 ms
Accuracy	(15 min warm-up time)
Temperature drift	± 1000 ppm/°C
Delay ON alarm	± 10% on set value ± 50 ms
Repeatability	± 0.5% on full-scale
Indication for	
Power supply ON	LED, green
Alarm ON	LED, red (flashing 2 Hz during delay time)
Output relay ON	LED, yellow
Environment	(EN 60529)
Degree of protection	IP 20
Pollution degree	3 (DIB01), 2 (PIB01)
Operating temperature	-20 to 60°C, R.H. < 95%
Storage temperature	-30 to 80°C, R.H. < 95%

Housing		
Dimensions	DIB01 PIB01	22.5 x 80 x 99.5 mm 36 x 80 x 94 mm
Material		PA66 or Noryl
Weight		Approx. 150 g
Screw terminals		
Tightening torque		Max. 0.5 Nm acc. to IEC 60947
Product standard		EN 60255-6
Approvals		UL, CSA
CE Marking		L.V. Directive 2006/95/EC EMC Directive 2004/108/EC
EMC		
Immunity		According to EN 60255-26 According to EN 61000-6-2
Emissions		According to EN 60255-26 According to EN 61000-6-3

Mode of Operation

DIB01 and PIB01 monitor both AC and DC over or under current through an internal shunt.

Example 1

(connection between terminals Z1, Y1 or 8, 9 - latching function enabled)

The relay operates and latches in operating position when the measured value

exceeds (or drops below) the set level for more than the set delay time. Provided that the current has dropped below (or has exceeded) the set point (see hysteresis setting), the relay releases when the interconnection between terminals Z1, Y1 or 8, 9 is interrupted or the power supply is interrupted as well.

The red LED flashes until the

delay time has expired or the measured value comes back to a non-alarm value (see hysteresis setting).

Example 2 (Standard CT)

(no connection between terminals Z1, Y1 or 8, 9 - latch function disabled)

The relay operates when the measured value exceeds (or drops below) the set level for

more than the set delay time. It releases when the current drops below (or exceeds) the set level (see hysteresis setting) or when power supply is interrupted.

Note

When the inhibit contact is opened, if the input signal is already in alarm position, the delay time needs to elapse before relay activation.

Function/Range/Level and Time Delay Setting

Adjust the input range setting the DIP switches 1 and 2 as shown below (except for models DIB01xxx10A and PIB01xxx10A). Select the desired function setting the DIP switches 3 to 6 (1 to 4 for DIB01xxx10A and PIB01xxx10A) as shown below.

To access the DIP switches open the grey plastic cover as shown below.

Selection of level and time delay:

Upper knob:

Setting of hysteresis on relative scale: 0 to 30% on set value.

Centre knob:

Current level setting on relative scale: 10 to 110% on full scale.

Lower knob:

Setting of delay on alarm time on absolute scale (0.1 to 30 s).

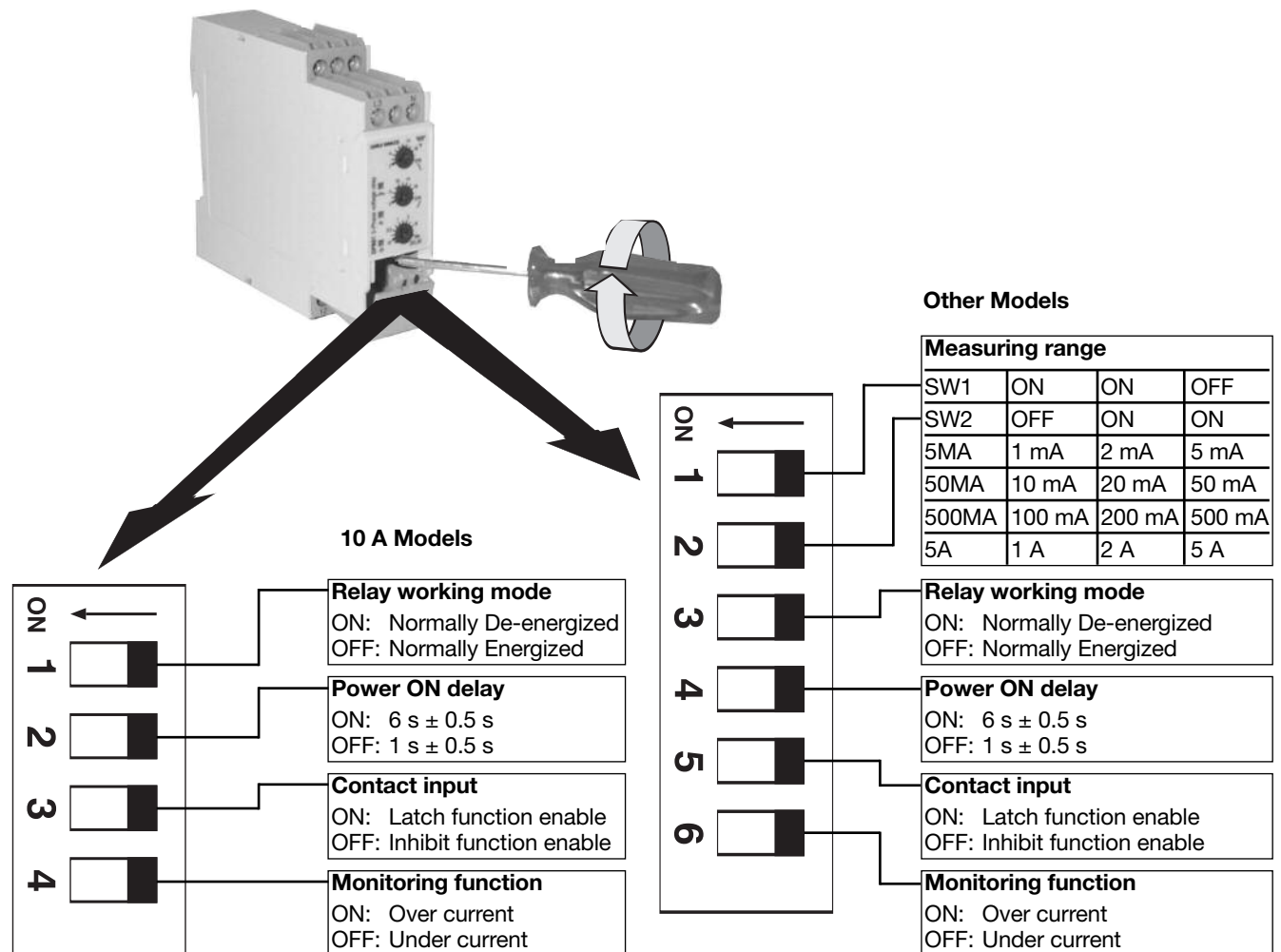

Operation Diagrams

Over current - N.D. relay

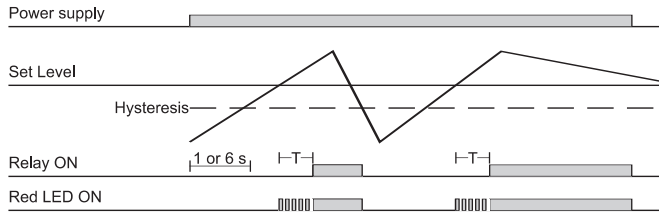

Under current - Latch function - N.D. relay

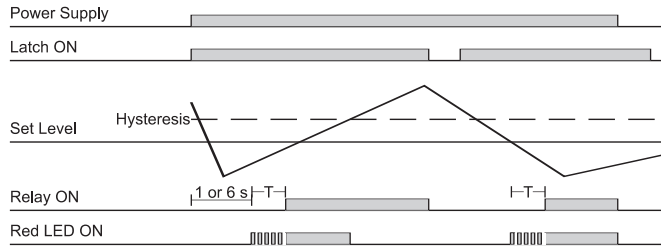

Under current - N.D. relay

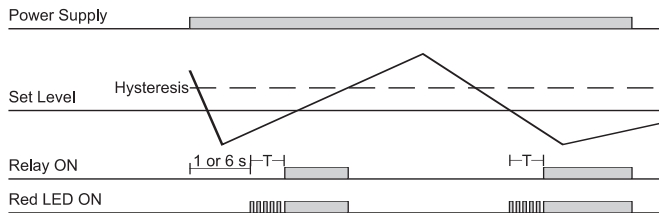

Over current - Inhibit function - N.D. relay

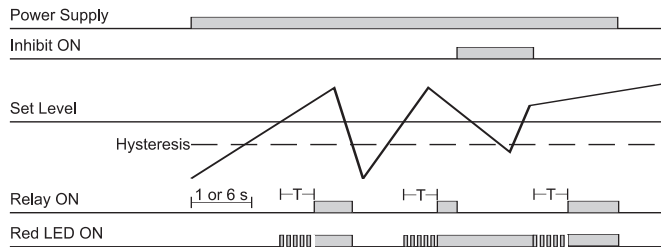

Wiring Diagrams

Example 1

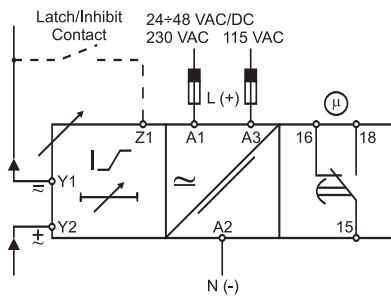

Example 2

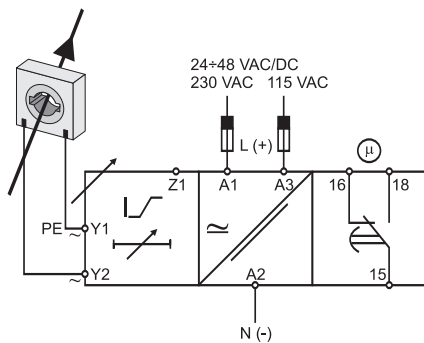

DIB01

Example 1

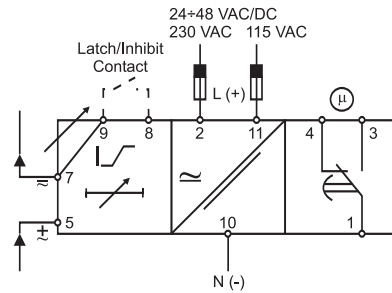

Example 2

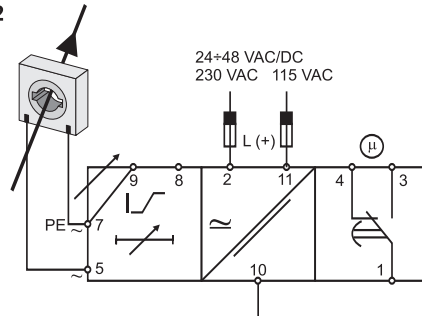

PIB01

Dimensions

