

Emergency Stop Switch A22E

Install in 22-dia. or 25-dia. Panel Cutout

- Direct opening mechanism to open the circuit when the contact welds →.
- Safety lock mechanism prevents operating errors.
- Easy mounting and removal of Switch Blocks using a lever.
- Mount three Switch Units in series to improve wiring efficiency (with non-lighted Switch Units, three Units can be mounted for multiple contacts).
- Finger protection mechanism on Switch Unit provided as a standard feature.
- Install using either round, or forked crimp terminals.
- Oil-resistant to IP65 (non-lighted models)/IP65 (lighted models)

Note: Be sure to read the precautions for all pushbutton switches in the *Pushbutton Switches Group Catalog* (Cat. No. X018), as well as the "Safety Precautions" on page 19.



Features

Safety Lock Mechanism to Prevent Misuse

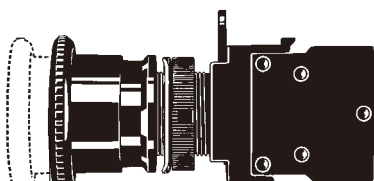

Lock position

This Switch enables emergency stops only when the pushbutton is pressed intentionally and firmly.

Even if an object or person touches the pushbutton by mistake, the contact will not be released unless the pushbutton reaches the lock position.

This Switch uses a finger protection mechanism to prevent electrical shocks. Moreover, it is provided with a mechanism to prevent terminal screws from coming off and also allows connection to either round or forked crimp terminals.

Finger protection

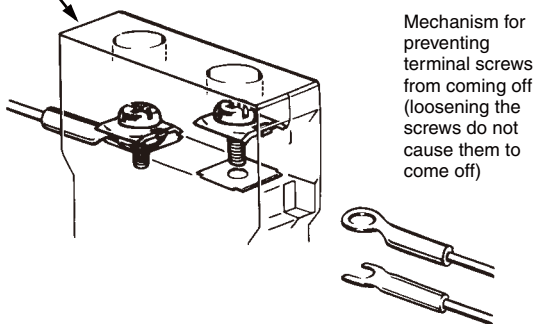

Mechanism for preventing terminal screws from coming off (loosening the screws do not cause them to come off)

Construction

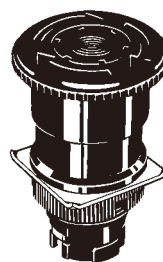

Operation Unit

Color: Red

- Non-lighted
- Lighted

Lamp

Light source

- LED Lamp
- Incandescent Lamp

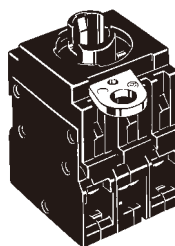

Switch

Contact Ratings

- 10 A at 110 VAC (resistive load)
- 10 A at 24 VDC (resistive load)

Lighting Method

- Non-lighted
- Lighted (without Voltage Reduction Unit)
- Lighted (with Voltage Reduction Unit)

(The above figures are examples of the lighted model.)

Model Number Structure

Model Number Legend

Completely Assembled

Shipped as a set which includes the Operation Unit, Lamp (lighted models only), and Switch.

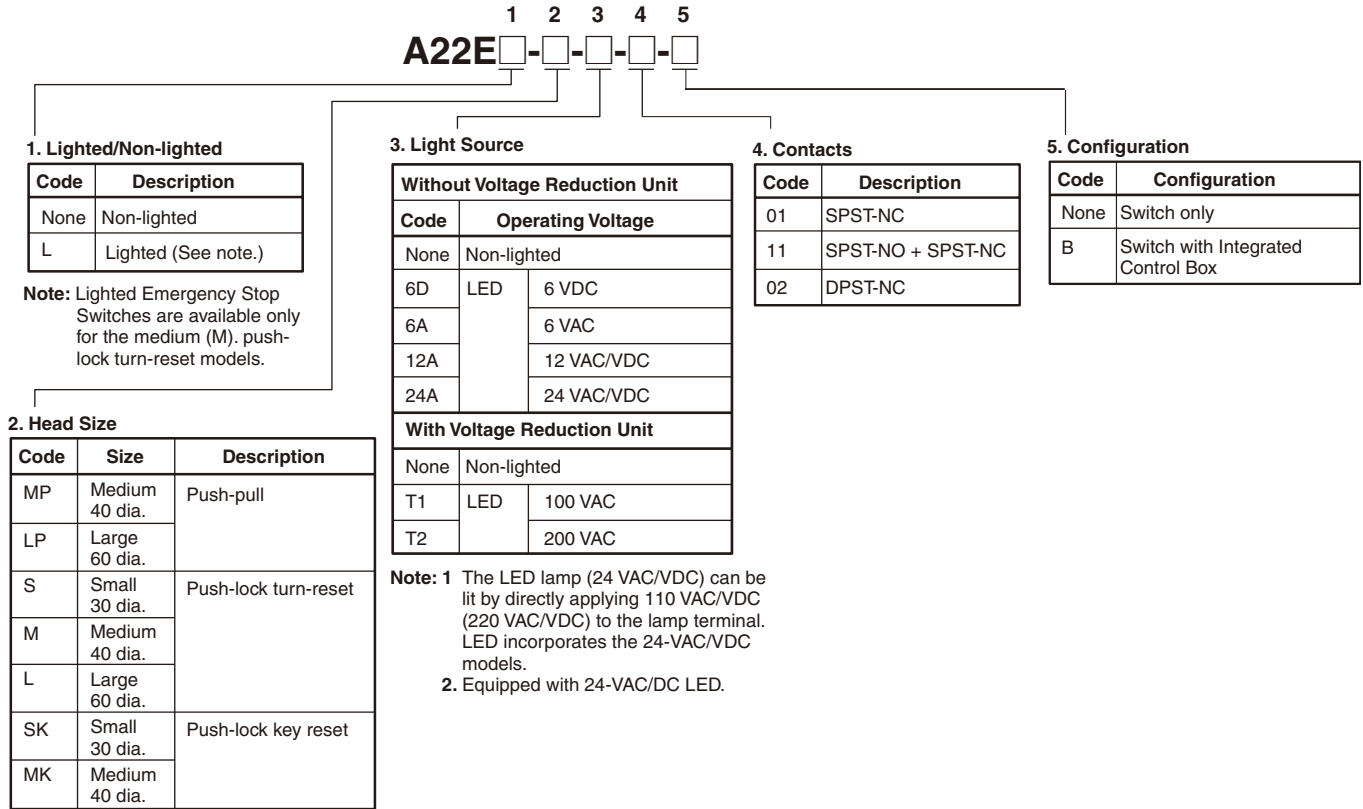

Ordering Information



■ List of Models

Completely Assembled

Non-lighted Models

Appearance	Output	Push-lock turn-reset system	Color of cap
40-dia. head Medium Push-pull A22E-MP 	SPST-NC	A22E-MP-01	Red
	SPST-NO/SPST-NC	A22E-MP-11	
	DPST-NC	A22E-MP-02	
60-dia. head Large Push-pull A22E-LP 	SPST-NC	A22E-LP-01	
	SPST-NO/SPST-NC	A22E-LP-11	
	DPST-NC	A22E-LP-02	
30-dia. head Small Push-lock Turn-reset A22E-S 	SPST-NC	A22E-S-01	
	SPST-NO/SPST-NC	A22E-S-11	
	DPST-NC	A22E-S-02	
	DPST-NC + SPST-NO	A22E-S12	
40-dia. head Medium Push-lock Turn-reset A22E-M 	SPST-NC	A22E-M-01	
	SPST-NO/SPST-NC	A22E-M-11	
	DPST-NC	A22E-M-02	
	DPST-NC + SPST-NO	A22E-M-12	
60-dia. head Large Push-lock Turn-reset A22E-L 	SPST-NC	A22E-L-01	
	SPST-NO/SPST-NC	A22E-L-11	
	DPST-NC	A22E-L-02	
	DPST-NC + SPST-NO	A22E-L-12	
30-dia. head Small Push-lock Key-reset A22E-SK 	SPST-NC	A22E-SK-01	
	SPST-NO/SPST-NC	A22E-SK-11	
	DPST-NC	A22E-SK-02	
40-dia. head Medium Push-lock Key-reset A22E-MK 	SPST-NC	A22E-MK-01	
	SPST-NO/SPST-NC	A22E-MK-11	
	DPST-NC	A22E-MK-02	

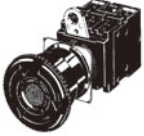
Lighted Models

Appearance	Output	Lighting	Rated voltage	Push-lock turn-reset system	Color of cap
40-dia. head Push-lock Turn-reset without Voltage Reduction Unit A22E 	SPST-NC	LED	6 VDC	A22EL-M-6D-01	Red
			6 VAC	A22EL-M-6A-01	
			12 VAC/VDC	A22EL-M-12A-01	
			24 VAC/VDC	A22EL-M-24A-01	
	SPST-NO/SPST-NC		6 VDC	A22EL-M-6D-11	
			6 VAC	A22EL-M-6A-11	
			12 VAC/VDC	A22EL-M-12A-11	
			24 VAC/VDC	A22EL-M-24A-11	
	DPST-NC		6 VDC	A22EL-M-6D-02	
			6 VAC	A22EL-M-6A-02	
			12 VAC/VDC	A22EL-M-12A-02	
			24 VAC/VDC	A22EL-M-24A-02	
40-dia. head Push-lock Turn-reset with Voltage Reduction Unit A22E 	SPST-NC	100 VAC	A22EL-M-T1-01		
	SPST-NO/SPST-NC	200 VAC	A22EL-M-T2-01		
		100 VAC	A22EL-M-T1-11		
	DPST-NC	200 VAC	A22EL-M-T2-11		
		100 VAC	A22EL-M-T1-02		
		200 VAC	A22EL-M-T2-02		

■ Switch with Integrated Control Box

Appearance	Output	Model
	SPST-NC	A22E-M-01B
	SPST-NO/SPST-NC	A22E-M-11B
	DPST-NC	A22E-M-02B

■ Subassembled

The Operation Unit, Lamp, or Switch can be ordered separately. Use them in combination for models that are not available as assembled Units. These can also be used as inventory for maintenance parts.

● Non-lighted

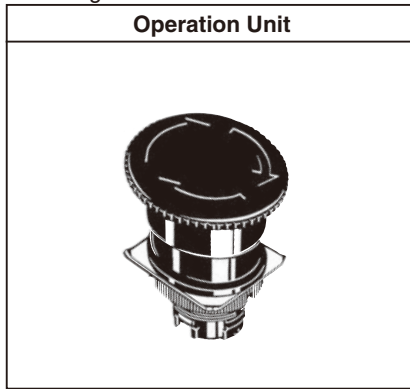

● Lighted (without Voltage Reduction Unit)

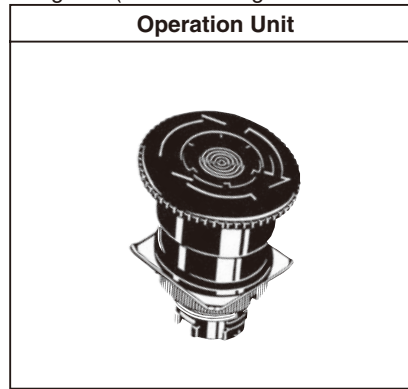



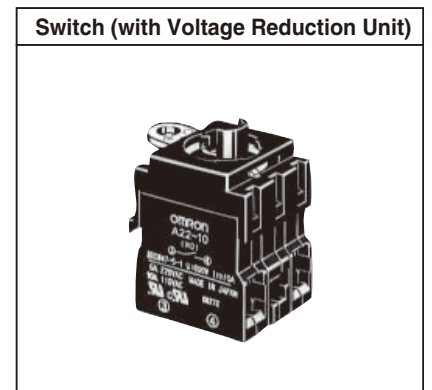
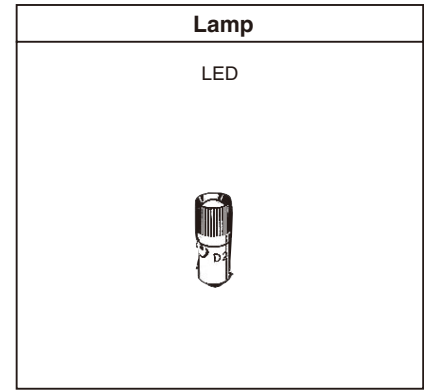
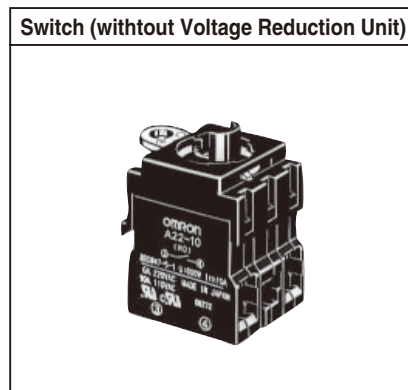
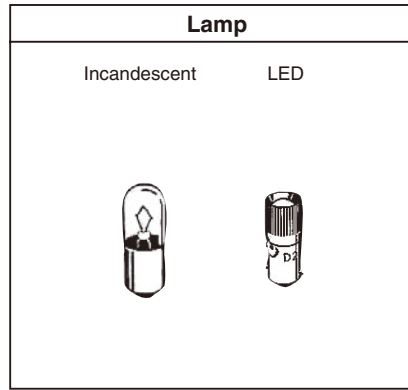
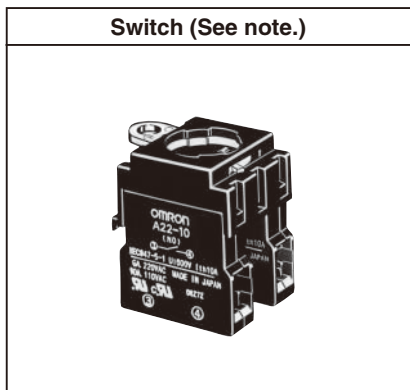
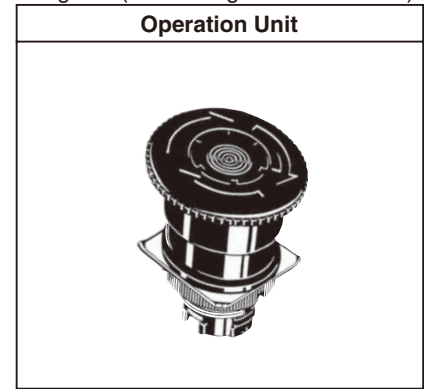

● Lighted (with Voltage Reduction Unit)



Note: Up to three Switch Units can be mounted for multiple contacts.

■ Operation Units

Non-lighted

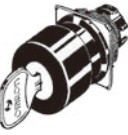
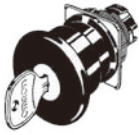
Sealing capability and size	IP65 oil-resistant models		
	Small (30 dia.)	Medium (40 dia.)	Large (60 dia.)
Push-pull	---	A22E-MP 	A22E-LP 
Push-lock, Turn-reset	A22E-S 	A22E-M 	A22E-L 
Push-lock, key-reset (push-lock, turn-reset)	A22E-SK 	A22E-MK 	---

Lighted

Sealing capability and size	IP65
	Medium (40 dia.)
Push-lock, Turn-reset	A22EL-M 

Lamp

LED

Appearance	LED light		Rated voltage	Model
	Red	Standard	6 VDC	A22-6DR
			6 VAC	A22-6AR
			12 VAC/VDC	A22-12AR
			24 VAC/VDC	A22-24AR
	Bright	24 VAC/VDC	A22-24ASR	

Note: For voltage-reduction lighting, use the A22-24AR.

Incandescent

Appearance	Rated voltage	Model
	6 VDC	A22-5
	14 VAC	A22-12
	28 VAC	A22-24
	130 VAC	A22-H1

Switch (Standard Load)

Without Voltage Reduction Unit

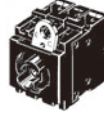



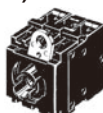
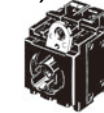









Classification Appearance		Non-lighted	Lighted
			
Switch Action		Momentary	Momentary
Contacts			
For standard loads	SPST-NO	A22-10M	A22L-10M
	SPST-NC	A22-01M	A22L-01M
	SPST-NO + SPST-NC	A22-11M	A22L-11M
	DPST-NO	A22-20M	A22L-20M
	DPST-NC	A22-02M	A22L-02M

With Voltage Reduction Unit

Classification Appearance		Lighted (110 VAC)	Lighted (220 VAC)
			
Switch Action		Momentary	Momentary
Contacts			
For standard loads	SPST-NO	A22L-10M-T1	A22L-10M-T2
	SPST-NC	A22L-01M-T1	A22L-01M-T2
	SPST-NO + SPST-NC	A22L-11M-T1	A22L-11M-T2
	DPST-NO	A22L-20M-T1	A22L-20M-T2
	DPST-NC	A22L-02M-T1	A22L-02M-T2

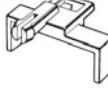
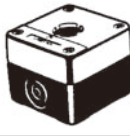
- Note:**
- The above illustrations are for the DPST-NO contact.
 - When using with a Voltage Reduction Unit, use the A22-24AR.

Accessories (Order Separately)

Item	Appearance	Classification	Model	Remarks	
Switch Blocks		SPST-NO	A22-10	Provided as standard. Order Switch Blocks only when adding or replacing them.	
		SPST-NC	A22-01		
		DPST-NO, one-piece	A22-20		
		DPST-NC, one-piece	A22-02		
Lamp Sockets		Direct lighting	A22-TN	Used when changing the lighting method.	
		Voltage-reduction lighting	100 VAC		A22-T1
			200 VAC		A22-T2
Mounting Latches		---	A22-3200	Provided as standard. Order Mounting Latches only when mounting Switch Blocks or Lamp Sockets that are purchased individually.	
Legend Plates for Emergency Stop		60-dia. black letters on yellow back-ground	A22Z-3466-1	"EMERGENCY STOP" is indicated on the plate.	
		90-dia. black letters on yellow back-ground	A22Z-3476-1		
		60-dia. black letters on yellow back-ground	A22Z-3466-2	"EMERGENCY OFF" is indicated on the plate.	
Hole Plug		Round	A22Z-3530	Can be plugged into pre-cut panel holes for future expansion. The color is black.	
Connectors		Applicable cable diameter (mm)	7 to 9 dia.	A22Z-3500-1	Plastic connector used to extend a cable from the Switch Box.
			9 to 11 dia.	A22Z-3500-2	
25-dia. Ring		---	A22Z-R25	Can be fit into a 25-dia. hole in the panel. Since this is not attached to the main body, order separately. (Refer to page 16.)	
30-dia. Resin Attachment		---	A22Z-A30	Can be fit into a 30-dia. hole in the panel. (Refer to page 16.)	
Lock Plate		---	A22Z-3380	Use to fix the lever on the Switch.	
Control Boxes (Enclosures)		One hole, yellow box (for emergency stop)	A22Z-B101Y	Material: Polycarbonate resin	
Operation Keys		---	A22K-K	Two keys are provided.	
Lock Ring		Rounded shape	A22Z-3360	The body is equipped with a Lock Fitting. This Lock Fitting is used when a more secure lock feature is required. (Refer to page 16.)	
Lamp Extractor		---	A22Z-3901	Rubber tool used to replace Lamps easily	
Tightening Tool		---	A22Z-3905	Tool used to tighten nuts from the back of the panel and to attach caps to lighted models.	

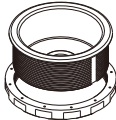
Item	Appearance	Classification	Model	Remarks
E-stop Shroud		---	A22Z-EG1	SEMI-S2/SEMATECH Application Guide for SEMI-S2-compatibility. The SEMI-S2-compatible Shroud and legend plate for EMERGENCY OFF come as a set. Use with an A22E Emergency Stop Switch.
E-stop Shroud		---	A22Z-EG2	SEMI-S2/SEMATECH Application Guide for SEMI S2-compatible Shroud. Use together with an A22E Emergency Stop Switch.

Specifications

■ Certified Standard Ratings

- UL, cUL (File No.E41515)
6A at 220 VAC, 10 A at 110 VAC
- TÜV (EN60947-5-1) (Low Voltage Directive)
3 A at 220VAC
- CCC (GB14048.5)
3 A at 240 VAC, 1.5 A at 24 VDC

■ Certified Standards

Certification body	Standards	File No.
UL (See note 2.)	UL508	E41515
TÜV Product Service	EN60947-5-1, EN60947-5-5 (certified direct opening mechanism)	Inquire
CQC (CCC)	GB14048.5	2003010303070635
KOSHA (See note 3.)	EN60947-5-1	2004-220

- Note:** 1. Only models with NC contacts have a direct opening mechanism.
2. UL-certification for CSA C22.2 No. 14 and bears the  mark.
3. Some models have been certified. Contact your OMRON sales representative.

■ Ratings

Contacts (Standard Load)

Rated carry current	Rated voltage	Rated current (A)			
		AC15 (inductive load)	AC12 (resistive load)	DC13 (inductive load)	DC12 (resistive load)
10 A	24 VAC	10	10	---	---
	110 VAC	5	10		
	220 VAC	3	6		
	380 VAC	2	3		
	440 VAC	1	2		
	24 VDC	---	---		
	110 VDC			0.5	2
	220 VDC			0.2	0.6
	380 VDC			0.1	0.2

- Note:** 1. Rated current values are determined according to the testing conditions. The above ratings were obtained by conducting tests under the following conditions.
(1) Ambient temperature: 20°±2°C
(2) Ambient humidity: 65±5%
(3) Operating frequency: 20 operations/minute
2. Minimum applicable load: 10 mA at 5 VDC

LED Indicators without Voltage Reduction Unit

Rated voltage	Rated current	Operating voltage
6 VDC	60 mA	6 VDC±5%
6 VAC	60 mA	6 VAC/VDC±5%
12 VAC/VDC	30 mA	12 VAC/VDC±5%
24 VAC/VDC	15 mA	24 VAC/VDC±5%

■ Characteristics

Item		Emergency Stop Switches	
		Non-lighted model: A22E	Lighted model: A22EL
Allowable operating frequency	Mechanical	30 operations/minute max. (See note 3.)	
	Electrical	30 operations/minute max. (See note 3.)	
Insulation resistance		100 M Ω min. (at 500 VDC)	
Dielectric strength	Between terminals of same polarity	2,500 VAC, 50/60 Hz for 1 min	
	Between each terminal and ground	2,500 VAC, 50/60 Hz for 1 min	
Vibration resistance		10 to 55 Hz, 1.5-mm double amplitude (See note 2.)	
Shock resistance	Destruction	1,000 m/s ²	
	Malfunction (See note 2.)	250 m/s ² max.	
Durability	Mechanical	300,000 operations min. (See note 3.)	
	Electrical	300,000 operations min. (See note 3.)	
Ambient operating temperature (See note 1.)		-20 to 70°C	-20 to 55°C
Ambient operating humidity		35% to 85%	
Ambient storage temperature		-40 to 70°C	
Degree of protection		IP65 (oil-resistant) (See note 4.)	IP65 (See note 4.)
Electric shock protection class		Class II	
PTI (tracking characteristic)		175	
Degree of contamination		3 (EN60947-5-1)	

- Note:**
1. With no icing or condensation.
 2. Malfunction within 1 ms.
 3. Setting and resetting once is counted as one operation.
 4. The degree of protection from the front of the panel.

Dimensions

Note: All units are in millimeters unless otherwise indicated.

Non-lighted Models

A22E-MP
Medium Push-pull (40-dia.)

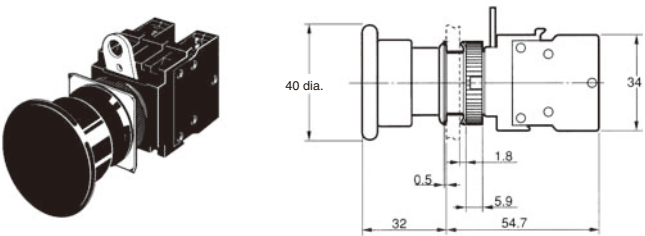

A22E-LP
Large Push-pull (60-dia.)

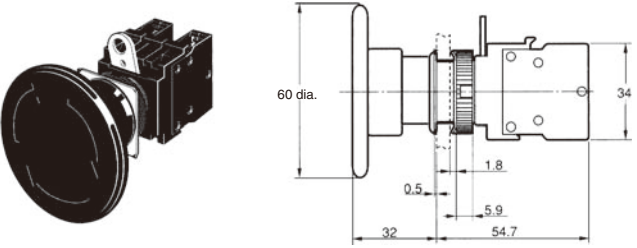

A22E-S
Small Push-lock, Turn-reset (30-dia.)

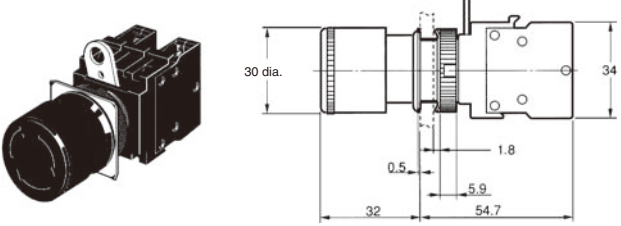

A22E-M
Medium Push-lock, Turn-reset (40-dia.)

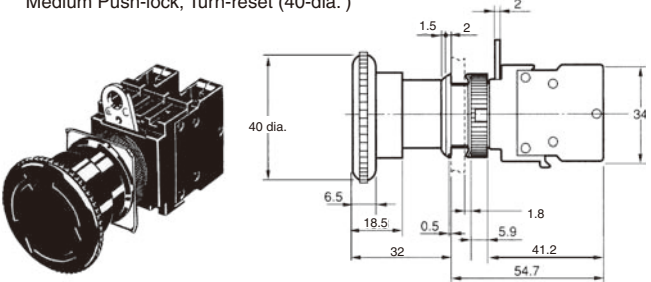

A22E-L
Large Push-lock, Turn-reset (60-dia.)

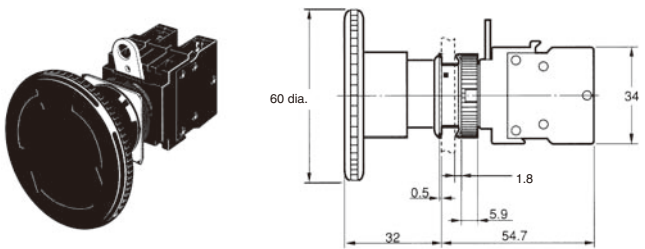

A22E-SK
Small Push-lock, Key-reset (30-dia.)

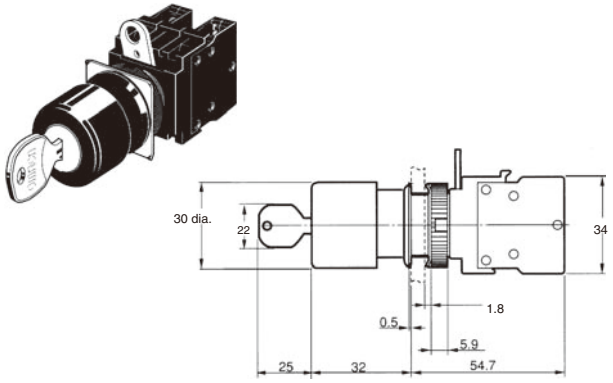

A22E-MK
Medium Push-lock, Key-reset (40-dia.)

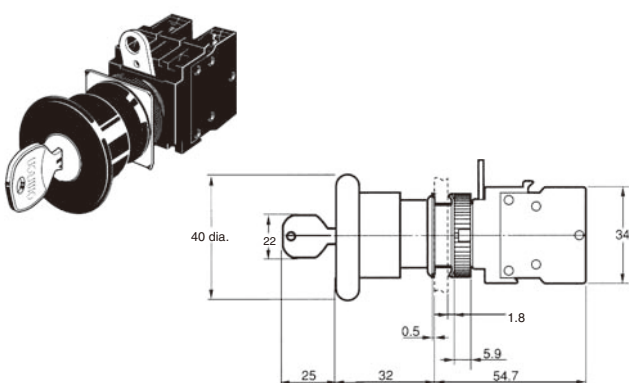

Lighted Models

A22EL-M

Medium Push-lock, Turn-reset (40-dia.)

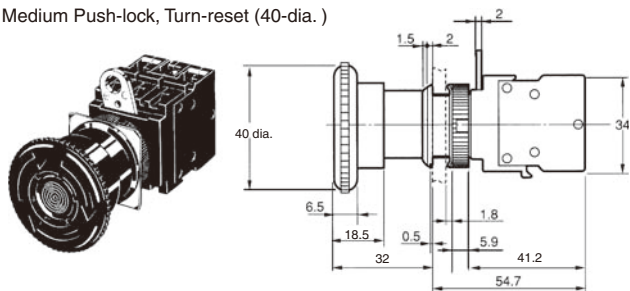

Switch dimensions when mounted to a DPST-NO (or DPST-NC) one-piece Switch Block

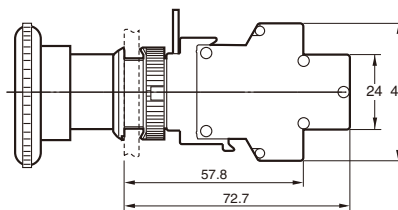

Note: The operation unit is an example for the A22E-M.

■ Dimensions for Accessories

Hole Plug

Round A22Z-3530

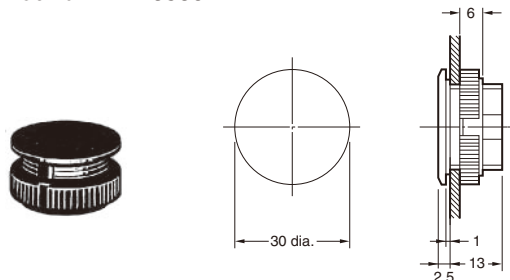

30-dia. Resin Attachment

A22Z-A30

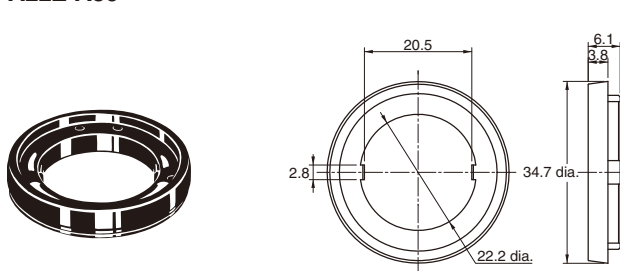

Lamp Extractor

A22Z-3901

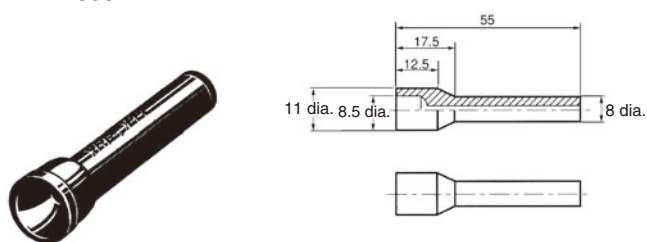

Tightening Wrench

A22Z-3905



Material: Chloroprene rubber

Legend Plates for Emergency Stop

A22Z-3476-1 (φ90)

A22Z-3466-1 (φ60)

A22Z-3466-2 (φ60)

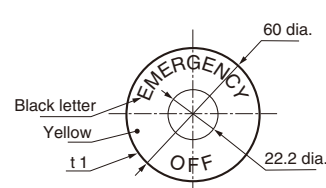
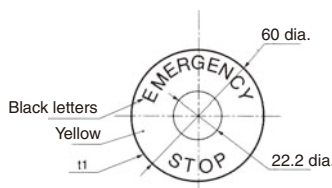
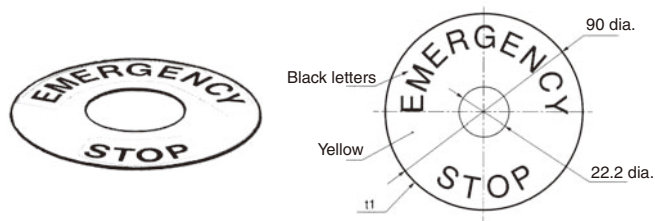

Lock Ring

A22Z-3360

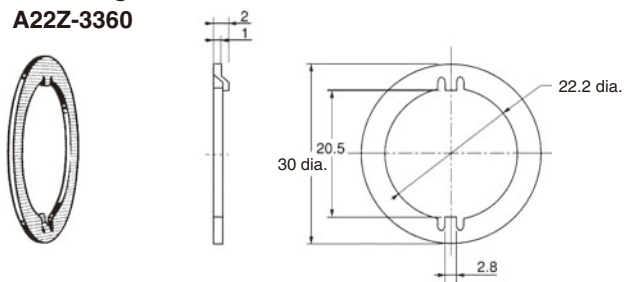

Material: Iron, zinc plated

25-dia. Ring

A22Z-R25

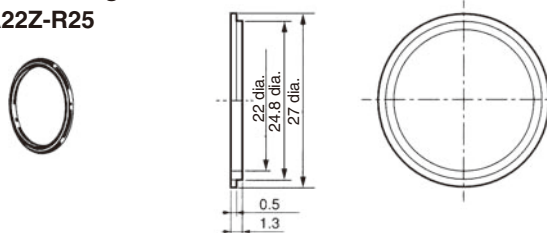

Material: NBR (black)

Lamp

LED A22-6□, 12□, 24□

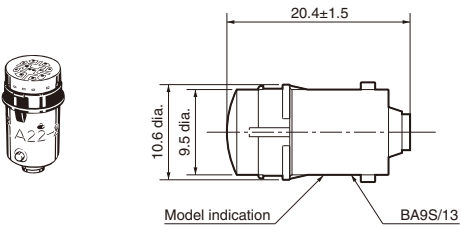

Incandescent Lamp A22-5, 12, 24, H1

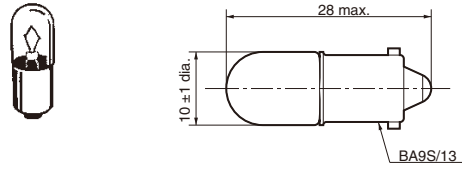

Control Box

A22Z-B101Y (1 hole)

Cable Draw-out Hole (Top View)

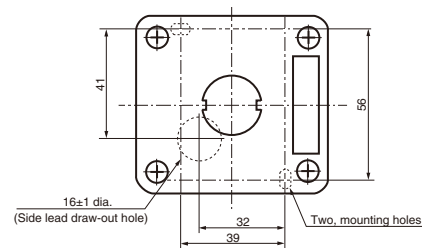
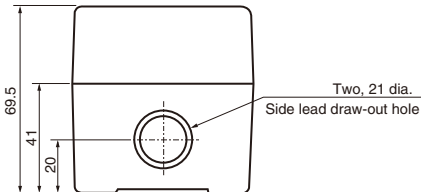
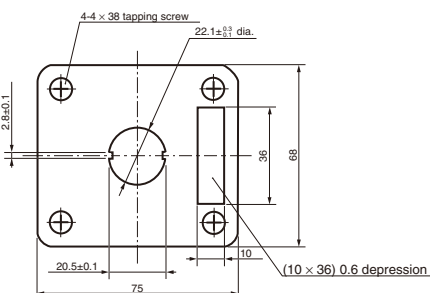

E-stop Shroud

A22Z-EG1

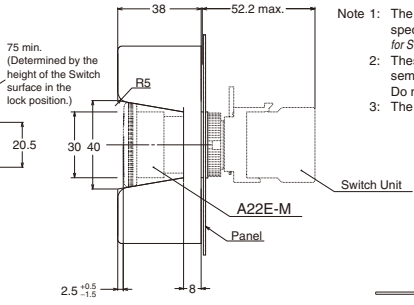
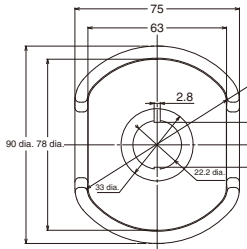

- Note 1: The dimensions of the Shroud conform to the specifications of the SEMATECH Application Guide for SEM S2-93.
 Note 2: These Shrouds are designed for use only in semiconductor manufacturing equipment. Do not use them for any other application.
 Note 3: The Shroud is not provided with the Switch.

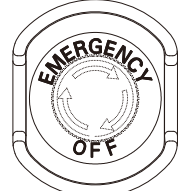

Panel Cutout Dimensions
 Allowable panel thickness: 1 to 3 mm

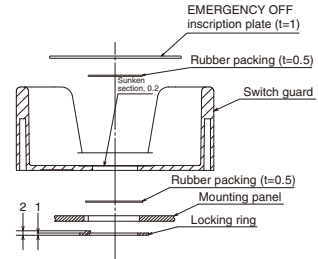

E-stop Shroud

A22Z-EG2, A22Z-EG21, A22Z-EG22

- Note 1: The dimensions of the Shroud conform to the specifications of the SEMATECH Application Guide for SEMI S2-93.
- Note 2: These Shrouds are designed for use only in semiconductor manufacturing equipment. Do not use them for any other application.
- Note 3: The Shroud is not provided with the Switch.

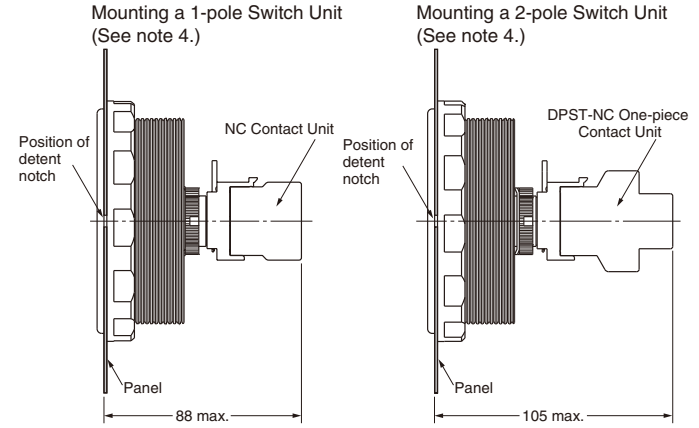
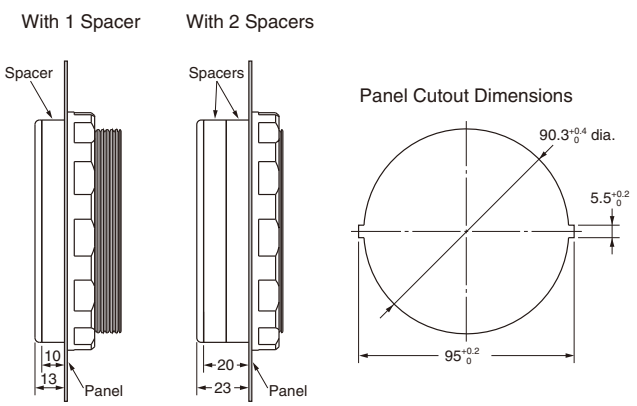
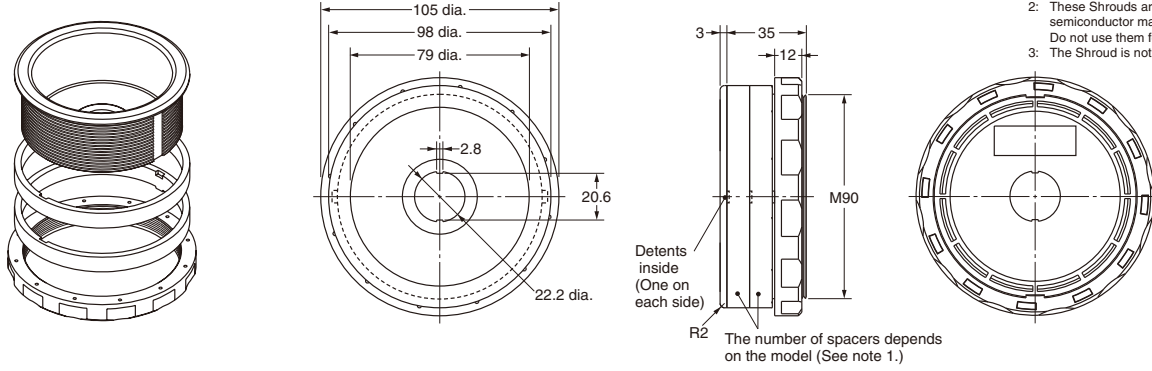

Note: 1. The number of Spacers that are combined depends on the model.

Model	No. of Spacers
A22Z-EG2	0
A22Z-EG21	1
A22Z-EG22	2

- 3. The allowable panel thicknesses are as follows:
 Without Spacers: $t=1.3$ to 22.5 mm
 With 1 Spacer: $t=1.3$ to 12.5 mm
 With 2 Spacers: $t=1.3$ to 2.5 mm
- 4. These are the dimension from the front of the panel when the Switch Unit is attached.

2. Tighten to a torque of 1.96 to 2.94 N·m.

■ Panel Cutouts

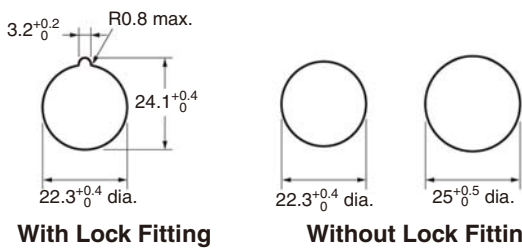

A Lock Ring is provided as a standard feature.

- Note: 1.** When painting or coating the panel, make sure that the specified panel dimensions apply to the panel after painting or coating.
- 2. Use an A22Z-R25 Ring when mounting to a panel with a 25-mm diameter hole.

Terminal Arrangement

Terminal Arrangement (Bottom View)

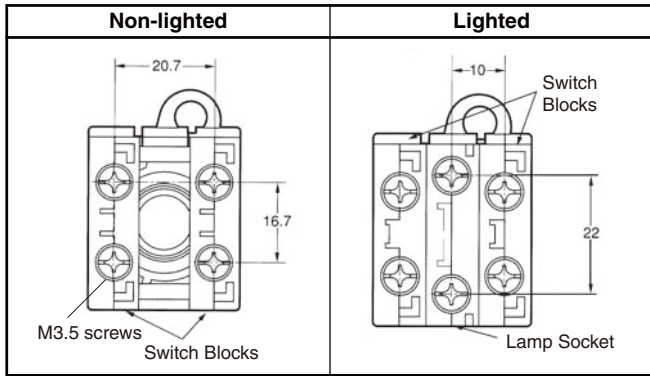

Terminal Connection

Type	Terminal connection (BOTTOM VIEW)	
	SPST-NO + SPST-NC	DPST-NC
Non-lighted		
Lighted without Voltage Reduction Unit		
Lighted with Voltage Reduction Unit		

Note: The above terminal connection diagrams are examples for SPST-NO + SPST-NC and DPST-NC.

Installation

Mounting to the Panel

(1) Preparing the Panel

- The panel dimensions are shown below.
- The panel thickness must be 1 to 5 mm.

With Lock Ring Without Lock Ring

- Always use a 25-mm-dia. Lock Ring for a 25-mm-dia. hole. IP65 degree of protection will be lost if the 25-mm-dia. Lock Ring is not used because of the larger size of a 25-mm-dia. hole.
- When painting or coating the panel, make sure that the specified panel dimensions apply to the panel after painting or coating.

(2) Matrix Mounting

- The following diagram provides the dimensions for mounting individual Switches, Legend Plates, and Lock Rings with leads connected directly to Switch terminals.
- The following diagram provides the dimensions for mounting Large Legend Plates with crimp terminals connected to Switch terminals.

Dimensions A and B between mounting hole centers are given in the following tables.

For 1., Above

Switch model	Dimension A
A22-10, A22-10S, A22-01, A22-01S	45 mm min.
A22-20, A22-20S, A-22-02, A22-02S, A22-11, A22-11S	55 mm min.

For 2., Above

Type of crimp terminal	Switch model	Dimension B
Naked crimp terminals	A22-10, A22-10S, A22-01, A22-01S	51 mm min.
	A22-20, A22-20S, A22-02, A22-02S, A22-11, A22-11S	61 mm min.
Crimp terminals with insulating sheaths	A22-10, A22-10S, A22-01, A22-01S	60 mm min.
	A22-20, A22-20S, A22-02, A22-02S, A22-11, A22-11S	70 mm min.

Note: 1. The above dimensions are the minimum dimensions when using the applicable wiring materials listed on page 19. If any other materials are used, check the suitability of dimensions in advance.
 2. When using pushbuttons exceeding 30 mm, adjust dimension A or B accordingly. (When mounting the A22-M□ in a matrix, "30 mm" would have to be increased to 40 mm.)

(3) Mounting the Operation Unit on the Panel

- Insert the Operation Unit from the front surface of the panel, insert the Lock Ring and the mounting nut from the terminal side, then tighten the nut. Before tightening, check that the rubber washer is present between the Operation Unit and the panel.
- When using a Legend Plate Frame, put one rubber washer each between the Legend Plate Frame and the panel and between the Operation Unit and the Legend Plate Frame. (One rubber washer will be provided when one Legend Plate Frame is ordered.)
- Align the Lock Ring with the groove in the casing, then insert the Lock Ring so that its edge is located on the panel side.
- Tighten the mounting nut at a torque of 0.98 to 1.96 N·m.
- When using a Lock Ring, replace with the supplied Lock Ring, insert the projecting part into the lock slot, and then tighten the mounting nut.

- When the panel cutout dimension is 25 dia., remove the supplied rubber washer and mount the 25-dia. Ring as shown below. (Since the A22Z-R25 is not attached to the main body, order separately.)
- When the panel cutout dimension is 25 dia., remove the supplied rubber washer and mount the 25-dia. Ring as shown below. (Since the A22Z-R25 is not attached to the main body, order separately.)

(4) Mounting the Switch on the Operation Unit

- Insert the Operation Unit into the Switch Unit, aligning the arrow mark inscribed on the Case with the lever on the Switch Blocks, then move the lever in the direction indicated by the arrow in the following figure.

(5) Removing the Switch

- Move the lever in the direction indicated by the arrow in the following figure, then pull the Operation Unit or the Switch Blocks. Since the lever has a hole with an inside diameter of 6.5 mm, the lever can be moved in the specified direction by inserting a screwdriver into the hole and then moving the screwdriver.

Assembling the Cap

Emergency Stop Switch

- Insert the protrusion of the Tightening Wrench (A22Z-3905) into the Cap slot and then turn to remove the Cap.

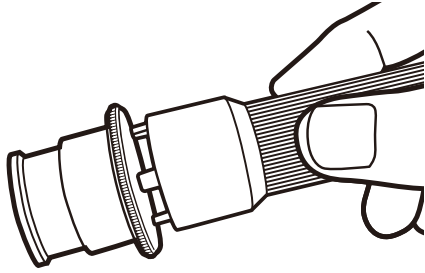

Installing/Replacing the Lamp

(1) Installing/Replacing from the Panel Surface

- Insert the Lamp Extractor (A22Z-3901) into the lamp, then rotate the Extractor while pressing it.

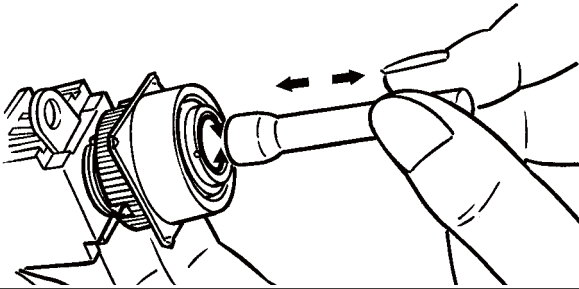

(2) Installing/Replacing on the Switch

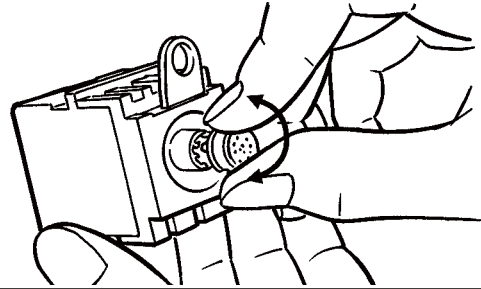

- Grip the indicator with your fingers, then rotate the indicator while pressing it against the Switch.

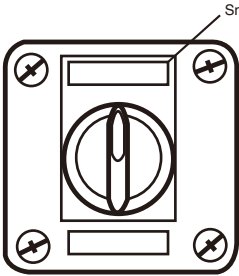
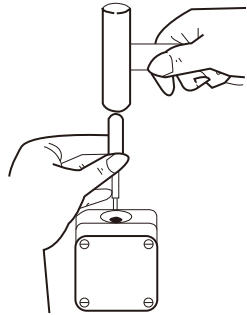
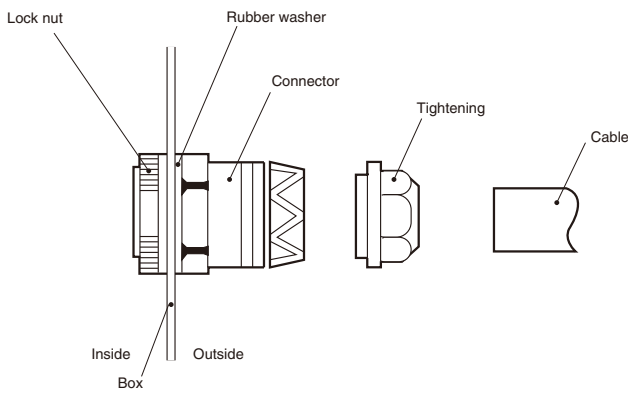

Control Box (Enclosure)

<p style="text-align: center;">(1) Mounting the Switch</p> <p>The Standard-size Legend Plate Frame can be mounted. Mount the Frame as shown in the following diagram. Mount the Switch in the same way as for an ordinary panel.</p>  <p style="text-align: center;">Snap-in Legend Plate</p>	<p style="text-align: center;">(2) Creating a Cable Port Hole</p> <p>Place the tip of a screwdriver on the surface where the cable port hole is to be created with the cover attached and strike the screwdriver to punch a hole. Attempts to punch a hole on the other side of the case will damage the Box.</p> 						
<p>(3) Securing the Connector Cable</p>							
<ol style="list-style-type: none"> 1. Insert the connector into the cable port hole in the Box and secure with the fixing nut inside the box. 2. Open a hole in the thin rubber section of the rubber ring. 3. Pass the tightening cap through the cable, insert the cable into the connector, and tighten the hexagonal nut to secure the cable. 							
	<table border="1" style="width: 100%; border-collapse: collapse;"> <thead> <tr> <th style="text-align: left;">Cable diameter</th> <th style="text-align: left;">Connector</th> </tr> </thead> <tbody> <tr> <td>7 to 9 dia.</td> <td>A22Z-3500-1</td> </tr> <tr> <td>9 to 11 dia.</td> <td>A22Z-3500-2</td> </tr> </tbody> </table>	Cable diameter	Connector	7 to 9 dia.	A22Z-3500-1	9 to 11 dia.	A22Z-3500-2
Cable diameter	Connector						
7 to 9 dia.	A22Z-3500-1						
9 to 11 dia.	A22Z-3500-2						

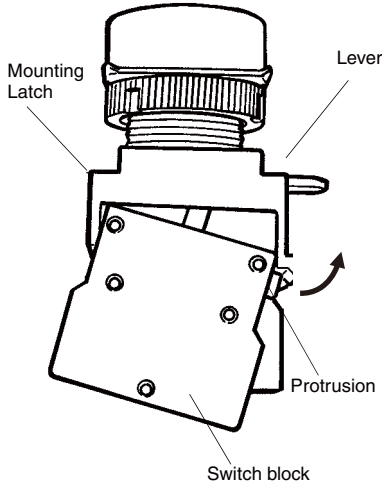
Installing/Removing the Switch Blocks

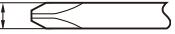
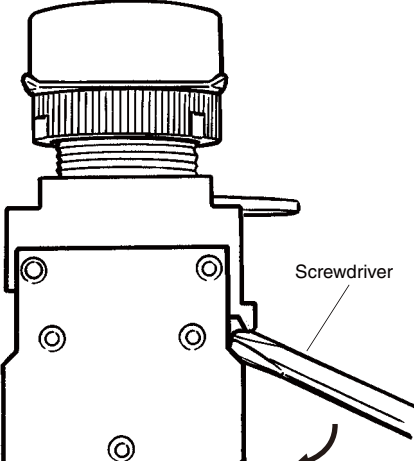
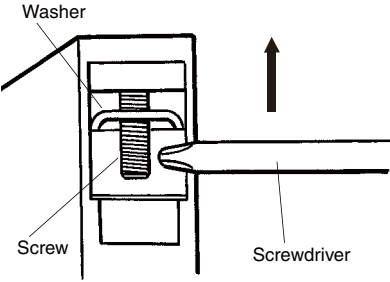
<p style="text-align: center;">(1) Installing the Switch Blocks</p> <ul style="list-style-type: none"> • Hook the small protrusion on the Mounting Latch into the groove on the other side of the lever, then push up the Switch Block in the direction indicated by the arrow in the figure below. 	<p style="text-align: center;">(2) Removing the Switch Blocks</p> <ul style="list-style-type: none"> • Insert a screwdriver between the Mounting Latch and the Switch Block, then push down the screwdriver in the direction indicated by the arrow in the following figure. <p>Use either of the following screwdrivers.</p> <p>Flat-head screwdriver 3 to 6 mm </p> <p>Phillips screwdriver 3 to 6 mm dia. </p> 	<p style="text-align: center;">Wiring</p> <ul style="list-style-type: none"> • Loosen the terminal screw from the Switch Unit until it completely comes off the groove, insert a screwdriver as shown in the following figure, then push up the washer in the direction indicated by the arrow to temporarily secure it. Now, a round crimp terminal can be connected. After inserting the terminal, tighten the screws to complete wiring. 
---	---	---

Safety Precautions

Be sure to read the precautions for all pushbutton switches in the *Pushbutton Switches Group Catalog* (Cat. No. X018).

CAUTION

Do not apply a voltage exceeding the rated voltage across the incandescent lamp terminals.
The lamp may be destroyed and the operation unit may fly out.

■ Precautions for Correct Use

Mounting

- Always make sure that the power is turned OFF before wiring the Switch. Also, do not touch the terminals or other current-carrying parts while power is being supplied. Electric shock may occur.
- Do not tighten the mounting ring more than necessary using tools such as pointed-nose pliers. Doing so will damage the mounting ring. The tightening torque is 0.98 to 1.96 N-m.
- Recommended panel thickness: 1 to 5 mm.

Wiring

- When DC-specific LEDs are used, wire the Switch so that the X1 terminal is positive.
- Terminal screws must be Phillips or slotted M3.5 screws with a square washer.
- The tightening torque is 1.08 to 1.27 N-m.
- Single wires, stranded wires, and crimp terminals can be connected to the Switch.
- Applicable Wiring Materials:
Twisted strands: 2 mm² max.
Solid wire: 1.6 mm dia.

Naked Crimp Terminals

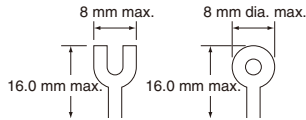

Crimp Terminals with Insulating Sheaths

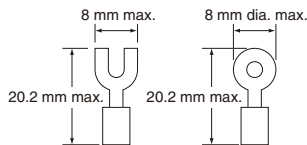

- After wiring the Switch, maintain an appropriate clearance and creepage distance.

Operating Environment

- The IP65 model is designed with a protective structure so that it will not sustain damage if it is subjected to water from any direction to the front of the panel.

LEDs

- The LED current-limiting resistor is built-in, so internal resistance is not required.
- If commercially available LEDs are used, select the ones that meet the following conditions:
Base: BA9S/13□
Overall length: 26 mm max.
Power consumption: 2.6 W max.

ALL DIMENSIONS SHOWN ARE IN MILLIMETERS.
To convert millimeters into inches, multiply by 0.03937. To convert grams into ounces, multiply by 0.03527.

Cat. No. A119-E1-06

In the interest of product improvement, specifications are subject to change without notice.

Using the Microload

- Contact failure may occur if a Switch designed for a standard load is used to switch a microload. Use Switches within the application ranges shown in the following graph. Even within the application range, insert a contact protection circuit, if necessary, to prevent the reduction of life expectancy due to extreme wear on the contacts caused by loads where inrush current occurs when the contact is opened and closed.
The minimum applicable load is the N-level reference value. This value indicates the malfunction reference level for the reliability level of 60% (λ 60) (conforming to JIS C5003).
The equation, λ 60 = 0.5×10^{-6} /time indicates that the estimated malfunction rate is less than 1/2,000,000 with a reliability level of 60%.

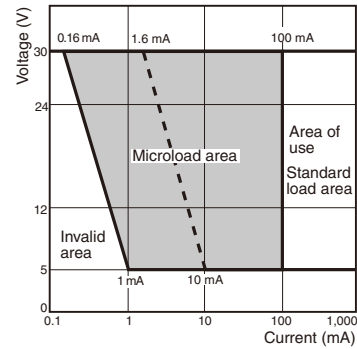

Others

- If the panel is to be coated, make sure that the panel meets the specified dimensions after coating.
- Due to the structure of the Switch, severe shock or vibration may cause malfunctions or damage to the Switch. Also, most Switches are made from resin and will be damaged if they come into contact with sharp objects. Particularly scratches on the Operation Unit may create visual and operational obtrusions. Handle the Switches with care, and do not throw or drop them.

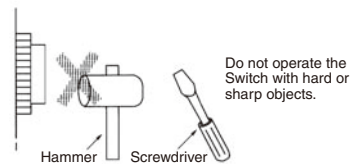
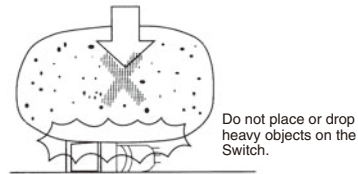
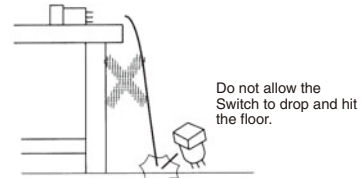



WARNING

This catalog is a guide to help customers select the proper safety products. Observe the following items when choosing products, select the right products for your devices or equipment, and develop a safety-related system to fully utilize product functions.

Setting Up a Risk Assessment System

The items listed in this catalog must be used properly in terms of product location as well as product performance and functionality. Part of the process of selecting and using these products should include the introduction and development of a risk assessment system early in the design development stage to help identify potential dangers in your equipment that will optimize safety product selection. A badly designed risk assessment system often results in poor choices when it comes to safety products.

- Related International Standards:
ISO 14121 Principles of Risk Assessment

Safety Policy

When developing a safety system for the devices and equipment that use safety products, make every effort to understand and conform to the entire series of international and industrial standards available, such as the examples given below.

- Related International Standards:
ISO 12100 Basic Concepts, General Principles for Design
IEC 61508 Functional Safety of Electrical/Electronic/Programmable Electronic Safety-related Systems

Role of Safety Products

Safety products have functions and mechanisms that ensure safety as defined by standards. These functions and mechanisms are designed to attain their full potential within safety-related systems. Make sure you fully understand all functions and mechanisms, and use that understanding to develop systems that will ensure optimal usage.

- Related International Standards:
ISO 14119 Interlocking Devices Associated with Guards-Principles for Design and Selection

Installing Safety Products

Make sure that properly educated and trained engineers are selected to develop your safety-related system and to install safety products in devices and equipment.

- Related International Standards:
ISO 12100 Basic Concepts, General Principles for Design
IEC 61508 Functional Safety of Electrical/Electronic/Programmable Electronic Safety-related Systems

Observing Laws and Regulations

Safety products should conform to pertinent laws, regulations, and standards, but make sure that they are used in accordance with the laws, regulations, and standards of the country where the devices and equipment incorporating these products are distributed.

- Related International Standards:
IEC 60204 Electrical Equipment of Machines

Observing Usage Precautions

Carefully read the specifications and precautions listed in this catalog for your product as well as all items in the Operating Manual packed with the product to learn usage procedures that will optimize your choice. Any deviation from precautions will lead to unexpected device or equipment failure not anticipated by safety-related systems or fire originating from equipment failure.

Transferring Devices and Equipment

When transferring devices and equipment, be sure to keep one copy of the Operating Manual and pack another copy with the device or equipment so the person receiving it will have no problem operating it.

- Related International Standards:
ISO 12100 Basic Concepts, General Principles for Design
IEC 61508 Functional Safety of Electrical/Electronic/Programmable Electronic Safety-related Systems

Read and Understand This Catalog

Please read and understand this catalog before purchasing the products. Please consult your OMRON representative if you have any questions or comments.

Warranty and Limitations of Liability

WARRANTY

OMRON's exclusive warranty is that the products are free from defects in materials and workmanship for a period of one year (or other period if specified) from date of sale by OMRON.

OMRON MAKES NO WARRANTY OR REPRESENTATION, EXPRESS OR IMPLIED, REGARDING NON-INFRINGEMENT, MERCHANTABILITY, OR FITNESS FOR PARTICULAR PURPOSE OF THE PRODUCTS. ANY BUYER OR USER ACKNOWLEDGES THAT THE BUYER OR USER ALONE HAS DETERMINED THAT THE PRODUCTS WILL SUITABLY MEET THE REQUIREMENTS OF THEIR INTENDED USE. OMRON DISCLAIMS ALL OTHER WARRANTIES, EXPRESS OR IMPLIED.

LIMITATIONS OF LIABILITY

OMRON SHALL NOT BE RESPONSIBLE FOR SPECIAL, INDIRECT, OR CONSEQUENTIAL DAMAGES, LOSS OF PROFITS, OR COMMERCIAL LOSS IN ANY WAY CONNECTED WITH THE PRODUCTS, WHETHER SUCH CLAIM IS BASED ON CONTRACT, WARRANTY, NEGLIGENCE, OR STRICT LIABILITY.

In no event shall responsibility of OMRON for any act exceed the individual price of the product on which liability is asserted.

IN NO EVENT SHALL OMRON BE RESPONSIBLE FOR WARRANTY, REPAIR, OR OTHER CLAIMS REGARDING THE PRODUCTS UNLESS OMRON'S ANALYSIS CONFIRMS THAT THE PRODUCTS WERE PROPERLY HANDLED, STORED, INSTALLED, AND MAINTAINED AND NOT SUBJECT TO CONTAMINATION, ABUSE, MISUSE, OR INAPPROPRIATE MODIFICATION OR REPAIR.

Application Considerations

SUITABILITY FOR USE

OMRON shall not be responsible for conformity with any standards, codes, or regulations that apply to the combination of products in the customer's application or use of the product.

At the customer's request, OMRON will provide applicable third party certification documents identifying ratings and limitations of use that apply to the products. This information by itself is not sufficient for a complete determination of the suitability of the products in combination with the end product, machine, system, or other application or use.

The following are some examples of applications for which particular attention must be given. This is not intended to be an exhaustive list of all possible uses of the products, nor is it intended to imply that the uses listed may be suitable for the products:

- Outdoor use, uses involving potential chemical contamination or electrical interference, or conditions or uses not described in this catalog.
- Nuclear energy control systems, combustion systems, railroad systems, aviation systems, medical equipment, amusement machines, vehicles, safety equipment, and installations subject to separate industry or government regulations.
- Systems, machines, and equipment that could present a risk to life or property.

Please know and observe all prohibitions of use applicable to the products.

NEVER USE THE PRODUCTS FOR AN APPLICATION INVOLVING SERIOUS RISK TO LIFE OR PROPERTY WITHOUT ENSURING THAT THE SYSTEM AS A WHOLE HAS BEEN DESIGNED TO ADDRESS THE RISKS, AND THAT THE OMRON PRODUCT IS PROPERLY RATED AND INSTALLED FOR THE INTENDED USE WITHIN THE OVERALL EQUIPMENT OR SYSTEM.

Disclaimers

CHANGE IN SPECIFICATIONS

Product specifications and accessories may be changed at any time based on improvements and other reasons.

It is our practice to change model numbers when published ratings or features are changed, or when significant construction changes are made. However, some specifications of the product may be changed without any notice. When in doubt, special model numbers may be assigned to fix or establish key specifications for your application on your request. Please consult with your OMRON representative at any time to confirm actual specifications of purchased product.

DIMENSIONS AND WEIGHTS

Dimensions and weights are nominal and are not to be used for manufacturing purposes, even when tolerances are shown.

ERRORS AND OMISSIONS

The information in this catalog has been carefully checked and is believed to be accurate; however, no responsibility is assumed for clerical, typographical, or proofreading errors, or omissions.

PERFORMANCE DATA

Performance data given in this catalog is provided as a guide for the user in determining suitability and does not constitute a warranty. It may represent the result of OMRON's test conditions, and the users must correlate it to actual application requirements. Actual performance is subject to the OMRON Warranty and Limitations of Liability.

PROGRAMMABLE PRODUCTS

OMRON shall not be responsible for the user's programming of a programmable product, or any consequence thereof.

COPYRIGHT AND COPY PERMISSION

This catalog shall not be copied for sales or promotions without permission.

This catalog is protected by copyright and is intended solely for use in conjunction with the product. Please notify us before copying or reproducing this catalog in any manner, for any other purpose. If copying or transmitting this catalog to another, please copy or transmit it in its entirety.