

Spéciales et techniques
Special lamps
Chapitre C2

Click Below To Order

Interlight Specialty Bulbs
1-800-743-0005
www.interlight.biz

Lampes médicales / *Medical lamps*



orbitec

LES LAMPES DE TOUS LES MÉTIERS - THE RIGHT LAMP FOR THE RIGHT JOB

C2/1

LAMPE POUR AMNIOSCOPE EFFNER
For Amnioscopy Effner



Echelle 1/Scale 1

Click Below To Order

Interlight Specialty Bulbs
1-800-743-0005
www.interlight.biz

CODE STOCK PART NUMBER	RÉFÉRENCE	VOLTS	VERRE GLASS	TYPE
125274	M 182	4,0	CLAIR/CLEAR	E 656

C2/2

LAMPES POUR RECTOSCOPE EFFNER
For Rectoscopy

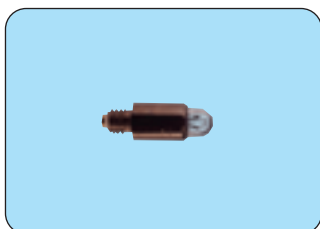

Echelle 1/Scale 1

CODE STOCK PART NUMBER	RÉFÉRENCE	VOLTS	VERRE GLASS	TYPE
125267	M 927	2,7	CLAIR/CLEAR	40 B
125268	M 900	4,0	CLAIR/CLEAR	40 B

C2/3

LAMPES POUR DIAPHANOSCOPE EFFNER
For diaphanoscope

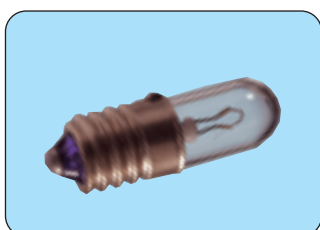

Echelle 1/Scale 1

CODE STOCK PART NUMBER	RÉFÉRENCE	VOLTS	VERRE GLASS
125155	ME 731	8	CLAIR/CLEAN

Third parties trademarks are mentioned in this catalogue when reference thereto is necessary to inform customers about the intended use of products sold by Orbitec. These trademarks remain the property of the manufacturers concerned.

SPECIAL LAMPS
SPECIALES ET TECHNIQUES

C2/4

POUR LARYNGOSCOPE EFFNER-SALING
For Laryngoscope



Echelle 1/Scale 1

Click Below To Order

Interlight Specialty Bulbs
1-800-743-0005
www.interlight.biz

CODE STOCK PART NUMBER	RÉFÉRENCE	VOLTS	VERRE GLASS	TYPE
125060	M 623	2,5	CLAIR/CLEAR	623

C2/5

POUR OTOSCOPE EFFNER ET MEDILUX
For Otoscopy



Echelle 1/Scale 1

CODE STOCK PART NUMBER	RÉFÉRENCE	VOLTS	VERRE GLASS	TYPE
125264	M 100	2,5	CLAIR/CLEAR	166-43 C
125265	M 138	3,8	CLAIR/CLEAR	166-43 C

C2/6

POUR ANAL-SPECULUM EFFNER

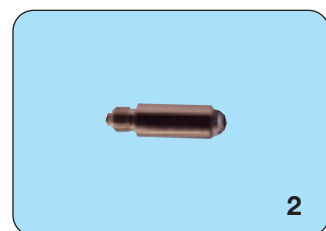

Echelle 1/Scale 1

CODE STOCK PART NUMBER	RÉFÉRENCE	VOLTS	VERRE GLASS	TYPE	PHOTO N° PICTURE N°
125269	M 127	2,7	CLAIR/CLEAR	168-44 D	2
125265	M 138	3,8	CLAIR/CLEAR	168-44 D	1

Des marques de tiers sont citées dans le présent catalogue lorsque leur référence est nécessaire pour informer ses clients de la destination de produits commercialisés par Orbitec. Ces marques restent la propriété des fabricants concernés.

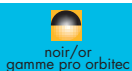

C2/7

POUR LARYNGOSCOPE FOREGGER-MILLER

For Laryngoscopy



Echelle 1/Scale 1

Click Below To Order

Interlight Specialty Bulbs
1-800-743-0005
www.interlight.biz

CODE STOCK PART NUMBER	RÉFÉRENCE	VOLTS	VERRE GLASS	TYPE
---------------------------	-----------	-------	----------------	------

POUR ENFANTS / For children

124998	M 167	2,5	CLAIR/CLEAR	EF1 AR-AVEC JOINT/WITH RING
--------	--------------	-----	-------------	-----------------------------

C2/8

POUR LARYNGOSCOPE FOREGGER-MILLER

For Laryngoscopy



1



2

Echelle 1/Scale 1

CODE STOCK PART NUMBER	RÉFÉRENCE	VOLTS	VERRE GLASS	TYPE	PHOTO N° PICTURE N°
---------------------------	-----------	-------	----------------	------	------------------------

POUR ENFANTS / For children

125150	MEF 1A	2,5	DÉPOLI/FROSTED	EF1 A	1
125151	MEF 1	2,5	CLAIR/CLEAR	EF1 A	1

POUR ADULTES / For adults

125105	MEF 4	2,5	DÉPOLI/FROSTED	EF4-AVEC POINT/WITH RING	2
--------	--------------	-----	----------------	--------------------------	---

C2/9

POUR ÉCLAIRAGE FRONTAL CLAR & JANSEN

For Head Light



Echelle 1/Scale 1

CODE STOCK PART NUMBER	RÉFÉRENCE	VOLTS	WATTS/ AMPÈRE	VERRE GLASS	TYPE
---------------------------	-----------	-------	------------------	----------------	------

125230	ME 56T/4	4	0,5 A	CLAIR/CLEAR	709-56 T
018970	OR 9059	6	6 W	CLAIR/CLEAR	
125235	ME 56T/8	8/10	3,5/5W	CLAIR/CLEAR	709-56 T

Third parties trademarks are mentioned in this catalogue when reference thereto is necessary to inform customers about the intended use of products sold by Orbitec. These trademarks remain the property of the manufacturers concerned.

C2/10

POUR OPHTHALMOSCOPE FRENZEL
For Ophthalmoscope



Echelle 1/Scale 1

Click Below To Order

Interlight Specialty Bulbs
1-800-743-0005
www.interlight.biz

CODE STOCK PART NUMBER	RÉFÉRENCE	VOLTS	VERRE GLASS	TYPE
125050	M 68	3,8	CLAIR/CLEAR	EFF 68

C2/11

POUR OTOSCOPE GOWLLANDS
For Otoscope

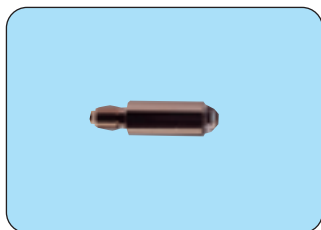

Echelle 1/Scale 1

CODE STOCK PART NUMBER	RÉFÉRENCE	VOLTS	VERRE GLASS	TYPE
125160	MEG 1	2,5	CLAIR/CLEAR	# 12

C2/12

POUR OTOSCOPE GOWLLANDS
For Otoscope

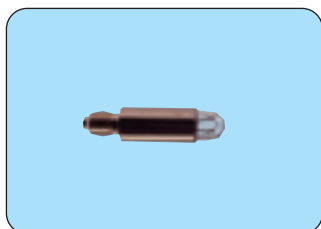

Echelle 1/Scale 1

CODE STOCK PART NUMBER	RÉFÉRENCE	VOLTS	VERRE GLASS	TYPE
125159	MEG 3	2,5	CLAIR/CLEAR	G3

Pour autres lampes Gowllands, nous consulter.

For others types, please consult us.

Des marques de tiers sont citées dans le présent catalogue lorsque leur référence est nécessaire pour informer ses clients de la destination de produits commercialisés par Orbitec. Ces marques restent la propriété des fabricants concernés.

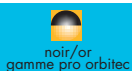

C2/13

POUR OPHTALMOSCOPE AUTOFOC HEINE
For Autofocus Ophthalmoscope



Echelle 1/Scale 1

Click Below To Order

Interlight Specialty Bulbs
1-800-743-0005
www.interlight.biz

CODE STOCK PART NUMBER	RÉFÉRENCE	VOLTS	TYPE	GAZ GAS
125169	MH 032	2,5	X01.88.032	HALOGÈNE
125224	MH 047	3,5	X02.88.047	HALOGÈNE

C2/14

POUR LOUPE ÉCLAIRANTE ALPHA HEINE
For Alpha Illuminating Lens



Echelle 1/Scale 1

CODE STOCK PART NUMBER	RÉFÉRENCE	VOLTS	TYPE	GAZ GAS
125180	MH 034	2,5	X01.88.034	HALOGÈNE

C2/15

POUR LARYNGOSCOPE - AMNIOSCOPE - HEINE
For Laryngoscope - Amnioscope



Echelle 1/Scale 1

CODE STOCK PART NUMBER	RÉFÉRENCE	VOLTS	TYPE	GAZ GAS
125170	MH 035	2,5	X01.88.035	HALOGÈNE
125191	MK 035	4,5	X01.88.035	KRYPTON
125175	MH 044	3,5	X02.88.044	HALOGÈNE

Third parties trademarks are mentioned in this catalogue when reference thereto is necessary to inform customers about the intended use of products sold by Orbitec. These trademarks remain the property of the manufacturers concerned.

C2/16

POUR OTOSCOPE, MIR. LARYNGÉ CINTRÉ ET ABAISSE-LANGUE, MINI 2000 - ALPHA - HEINE / For Otoscope, tongue-blade holders



Echelle 1/Scale 1

Click Below To Order

Interlight Specialty Bulbs
1-800-743-0005
www.interlight.biz

CODE STOCK PART NUMBER	RÉFÉRENCE	VOLTS	TYPE	GAZ GAS
125171	MH 037	2,5	X01.88.037	HALOGÈNE
125179	MK 037	2,5	X01.88.037	KRYPTON
125225	MH 062	3,5	X02.88.062	HALOGÈNE
125226	MH 049	3,5	X02.88.049	HALOGÈNE

C2/17

POUR OPHTALM. MIROFLEX, LOUPE ÉCLAIR. ET SKIASCOPE, DELTA 10, HFR2 FLECK - HEINE / For Ophthalmoscope

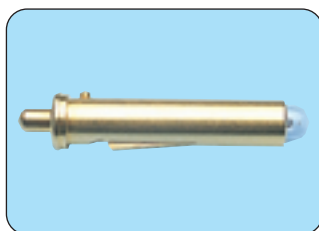

Echelle 1/Scale 1

CODE STOCK PART NUMBER	RÉFÉRENCE	VOLTS	TYPE	GAZ GAS
125168	MH 038	2,5	X01.88.038	HALOGÈNE
125227	MH 046	3,5	X02.88.046	HALOGÈNE

C2/18

POUR FOCALUX HEINE



Echelle 1/Scale 1

CODE STOCK PART NUMBER	RÉFÉRENCE	VOLTS	TYPE	GAZ GAS
125181	MH 039	2,5	X01.88.039	HALOGÈNE
125228	MH 091	3,5	X02.88.091	HALOGÈNE

Des marques de tiers sont citées dans le présent catalogue lorsque leur référence est nécessaire pour informer ses clients de la destination de produits commercialisés par Orbitec. Ces marques restent la propriété des fabricants concernés.

C2/19

POUR PROCTOSCOPE HEINE
For Proctoscope



Echelle 1/Scale 1

Click Below To Order

Interlight Specialty Bulbs
1-800-743-0005
www.interlight.biz

CODE STOCK PART NUMBER	RÉFÉRENCE	VOLTS	TYPE	GAZ GAS
125176	MH 040	2,5	X01.88.040	HALOGÈNE
125229	MH 051	3,5	X02.88.051	HALOGÈNE

C2/20

POUR OTOSCOPE MINI-FIBRALUX HEINE
For Mini-Fibralux Otoscope



Echelle 1/Scale 1

CODE STOCK PART NUMBER	RÉFÉRENCE	VOLTS	TYPE	GAZ GAS
125109	M 102	2,5	X01.88.041	HALOGÈNE
125192	MK 041	2,5	X01.88.041	KRYPTON

C2/21

POUR OPHTALMOSCOPE ET FOCALUX (ALPHA ET MINI) HEINE
For Ophthalmoscope

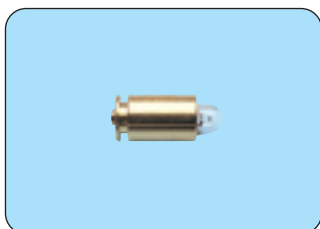

Echelle 1/Scale 1

CODE STOCK PART NUMBER	RÉFÉRENCE	VOLTS	TYPE	GAZ GAS
125172	MH 042	2,5	X01.88.042	HALOGÈNE

Third parties trademarks are mentioned in this catalogue when reference thereto is necessary to inform customers about the intended use of products sold by Orbitec. These trademarks remain the property of the manufacturers concerned.

C2/22

POUR OPHTALMOSCOPE ALPHA HEINE
For Ophthalmoscope

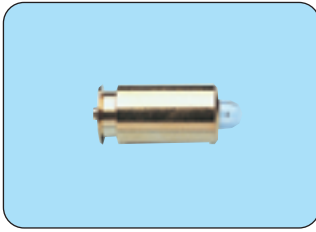

Echelle 1/Scale 1

Click Below To Order

Interlight Specialty Bulbs
1-800-743-0005
www.interlight.biz

CODE STOCK PART NUMBER	RÉFÉRENCE	VOLTS	TYPE	GAZ GAS
125182	MH 043	2,5	X01.88.043	HALOGÈNE

C2/23

POUR OTOSCOPE MINILUX HEINE
For Minilux Otoscope



Echelle 1/Scale 1

CODE STOCK PART NUMBER	RÉFÉRENCE	VOLTS	TYPE	GAZ GAS
125110	M 103	2,5	X01.88.056	HALOGÈNE
125193	MK 056	2,5	X01.88.056	KRYPTON

C2/24

POUR SKIASCOPE A FENTE HEINE
For Skiascope

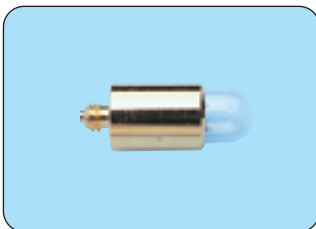

Echelle 1/Scale 1

CODE STOCK PART NUMBER	RÉFÉRENCE	VOLTS	TYPE	GAZ GAS
125183	MH 058	2,5	X01.88.058	HALOGÈNE
125187	MH 048	3,5	X02.88.048	HALOGÈNE

Des marques de tiers sont citées dans le présent catalogue lorsque leur référence est nécessaire pour informer ses clients de la destination de produits commercialisés par Orbitec. Ces marques restent la propriété des fabricants concernés.

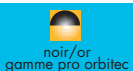

2/25

POUR LARYNGOSCOPE HEINE

For Laryngoscope



1



2

Echelle 1/Scale 1

Click Below To Order

Interlight Specialty Bulbs
1-800-743-0005
www.interlight.biz

CODE STOCK PART NUMBER	RÉFÉRENCE	VOLTS	TYPE	GAZ GAS	PHOTO N° PICTURE N°
125177	MH 059	2,5	X01.88.059	HALOGÈNE	1
125178	MK 059	2,5	X01.88.059	KRYPTON	1
125135	MH 057	2,5	X01.88.057	HALOGÈNE	2
125136	MH 063	3,5	X02.88.063	HALOGÈNE	2

2/26

POUR OPHTALMOSCOPE BETA 200 HEINE

For Ophthalmoscope

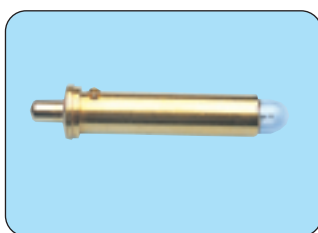

Echelle 1/Scale 1

CODE STOCK PART NUMBER	RÉFÉRENCE	VOLTS	TYPE	GAZ GAS
127175	MH 069	2,5	X01.88.069	HALOGÈNE
125236	MH 070	3,5	X02.88.070	HALOGÈNE

2/27

LAMPES POUR DERMATOSCOPE DELTA 10 PLUS HEINE

For Dermatoscope



Echelle 1/Scale 1

CODE STOCK PART NUMBER	RÉFÉRENCE	VOLTS	TYPE	GAZ GAS
125184	MH 077	2,5	X01.88.077	HALOGÈNE
125237	MH 078	3,5	X02.88.078	HALOGÈNE

Third parties trademarks are mentioned in this catalogue when reference thereto is necessary to inform customers about the intended use of products sold by Orbitec. These trademarks remain the property of the manufacturers concerned.

C2/28

POUR OPHTALMOSCOPE HEINE
For Ophthalmoscope



Echelle 1/Scale 1

Click Below To Order

Interlight Specialty Bulbs
1-800-743-0005
www.interlight.biz

CODE STOCK PART NUMBER	RÉFÉRENCE	VOLTS	TYPE	GAZ GAS
125320	MH 084	2,5	X01.88.084	HALOGÈNE
125321	MH 086	3,5	X02.88.086	HALOGÈNE

C2/29

POUR OPHTALMOSCOPE ET LAMPE À CLIP HEINE
For Ophthalmoscope



1

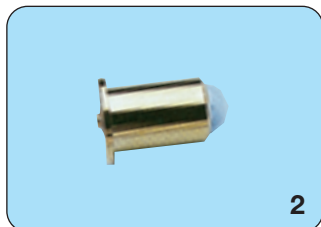

2

Echelle 1/Scale 1

CODE STOCK PART NUMBER	RÉFÉRENCE	VOLTS	TYPE	GAZ GAS	PHOTO N° PICTURE N°
125322	MH 094	2,5	X01.88.094	HALOGÈNE	1
125323	MH 098	2,5	X02.88.098	HALOGÈNE	2
125324	MH 099	3,5	X02.88.099	HALOGÈNE	2

C2/30

POUR OPHTALMOSCOPE INDIRECT HEINE
For Ophthalmoscope

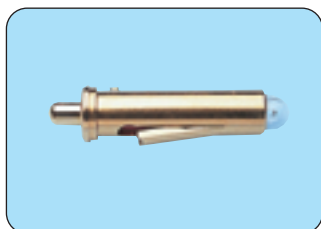

Echelle 1/Scale 1

CODE STOCK PART NUMBER	RÉFÉRENCE	VOLTS	TYPE	GAZ GAS
125188	MH 050	3,5	X02.88.050	HALOGÈNE
125221	MH 081	6	X04.88.081	HALOGÈNE

Des marques de tiers sont citées dans le présent catalogue lorsque leur référence est nécessaire pour informer ses clients de la destination de produits commercialisés par Orbitec. Ces marques restent la propriété des fabricants concernés.



C2/31

POUR OPHTALMOSCOPE SIGMA 100 HEINE
For Ophthalmoscope

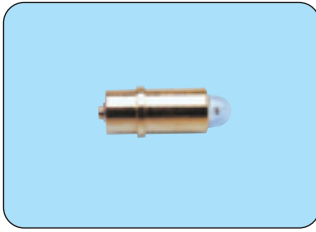

Echelle 1/Scale 1

Click Below To Order

Interlight Specialty Bulbs
1-800-743-0005
www.interlight.biz

CODE STOCK PART NUMBER	RÉFÉRENCE	VOLTS	TYPE	GAZ GAS
125189	MH 076	6	X04.88.076	HALOGÈNE

C2/32

POUR POIGNEE D'ECLAIRAGE HEINE
For light handle

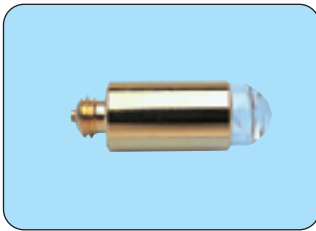

Echelle 1/Scale 1

CODE STOCK PART NUMBER	RÉFÉRENCE	VOLTS	TYPE	GAZ GAS
125173	MH 060	6	X04.88.060	HALOGÈNE

C2/33

POUR OPHTALMOSCOPE OMEGA ET LAMPE FRONTALE HEINE
For Ophthalmoscope and Headlight



Echelle 1/Scale 1

CODE STOCK PART NUMBER	RÉFÉRENCE	VOLTS	TYPE	GAZ GAS
125174	MH 068	6	X04.88.068	HALOGÈNE

Third parties trademarks are mentioned in this catalogue when reference thereto is necessary to inform customers about the intended use of products sold by Orbitec. These trademarks remain the property of the manufacturers concerned.

C2/34

POUR LUNETTES-LOUPES HEINE
For Binocular Lens Heine



Echelle 1/Scale 1

Click Below To Order

Interlight Specialty Bulbs
1-800-743-0005
www.interlight.biz

CODE STOCK PART NUMBER	RÉFÉRENCE	VOLTS	TYPE	GAZ GAS
125190	MH 080	6	X04.88.080	HALOGÈNE

C2/35

POUR OPHTHALMOSCOPE HEINE
For Ophthalmoscope

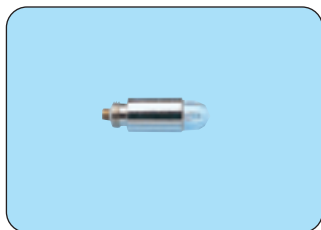

Echelle 1/Scale 1

CODE STOCK PART NUMBER	RÉFÉRENCE	VOLTS	TYPE
125261	M 725	2,5	EFFNER 47 A
125262	M 740	3,5	EFFNER 47 A

C2/36

POUR RETINOSCOPE BETA 200 HEINE
For Retinoscope

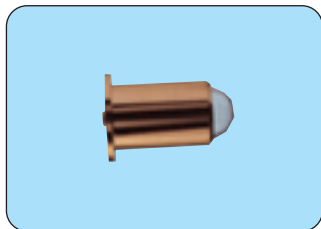

Echelle 1/Scale 1

CODE STOCK PART NUMBER	RÉFÉRENCE	VOLTS	TYPE	GAZ GAS
125185	MH 087	2,5	X01.88.087	HALOGÈNE
125222	MH 089	3,5	X02.88.089	HALOGÈNE

Des marques de tiers sont citées dans le présent catalogue lorsque leur référence est nécessaire pour informer ses clients de la destination de produits commercialisés par Orbitec. Ces marques restent la propriété des fabricants concernés.

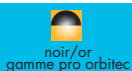

C2/37

POUR RETINOSCOPE BETA 200 (SPOT) HEINE

For Retinoscope

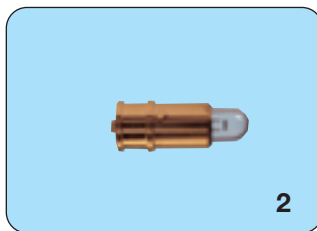
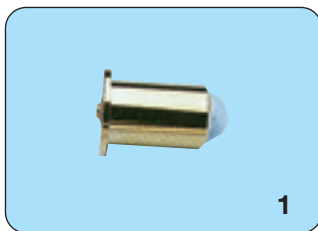

Click Below To Order

Interlight Specialty Bulbs
1-800-743-0005
www.interlight.biz

Echelle 1/Scale 1

CODE STOCK PART NUMBER	RÉFÉRENCE	VOLTS	TYPE	GAZ GAS	PHOTO N° PICTURE N°
125186	MH 088	2,5	X01.88.088	HALOGÈNE	1
125223	MH 090	3,5	X02.88.090	HALOGÈNE	1
125194	MH 093	6	X04.88.093	HALOGÈNE	2

C2/38

POUR RECTOSCOPE HEINE

For Rectoscope

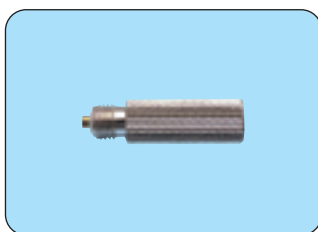

Echelle 1/Scale 1

CODE STOCK PART NUMBER	RÉFÉRENCE	VOLTS	TYPE
125113	M 104/2	2,5	104
125112	M 104/4	4	104

C2/39

POUR OTOSCOPE HEINE (ANCIEN MODÈLE)

For Otoscope



Echelle 1/Scale 1

CODE STOCK PART NUMBER	RÉFÉRENCE	VOLTS	TYPE	PHOTO N° PICTURE N°
125106	M 41A	2,5	41 A	1
125255	M 99	2,5	EFFNER 99	2

Third parties trademarks are mentioned in this catalogue when reference thereto is necessary to inform customers about the intended use of products sold by Orbitec. These trademarks remain the property of the manufacturers concerned.

C2/40

POUR CYSTOSCOPE HEYNEMANN
For Cystoscope

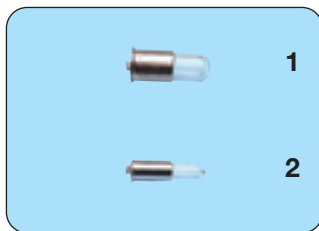

Echelle 1/Scale 1

Click Below To Order

Interlight Specialty Bulbs
1-800-743-0005
www.interlight.biz

CODE STOCK PART NUMBER	RÉFÉRENCE	VOLTS	VERRE GLASS	PHOTO N° PICTURE N°
125044	M 35	4	CLAIR/CLEAR	1
125045	M 37	4	CLAIR/CLEAR	2

C2/41

POUR OPHTALMOSCOPE OCULUS ET ECLAIREUR FRONTAL CLAR
For Ophthalmoscope and head light

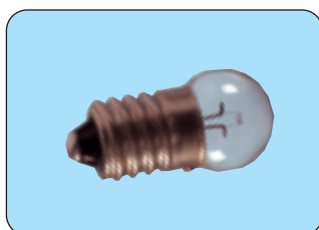

Echelle 1/Scale 1

CODE STOCK PART NUMBER	RÉFÉRENCE	VOLTS	VERRE GLASS	TYPE
125232	M 50 T/4	4	CLAIR/CLEAR	-
125233	M 50 T/6	6	CLAIR/CLEAR	-
125234	M 50 T/9	9	CLAIR/CLEAR	-
125245	M 10720	6 V 0,6 A		10080
125250	M 10680	6 V 6 W		10050

Pour autres lampes oculus, nous consulter.

For other types, please consult us.

C2/42

POUR OPHTALMOSCOPE LUNEAU
For Ophthalmoscope



Echelle 1/Scale 1

CODE STOCK PART NUMBER	RÉFÉRENCE	VOLTS	WATTS/ AMPÈRE	VERRE GLASS
125300	M 1015	2,5	0,44 A	CLAIR/CLEAR

Des marques de tiers sont citées dans le présent catalogue lorsque leur référence est nécessaire pour informer ses clients de la destination de produits commercialisés par Orbitec. Ces marques restent la propriété des fabricants concernés.

C2/43

POUR OPHTALMOSCOPE LUNEAU
For Ophthalmoscope

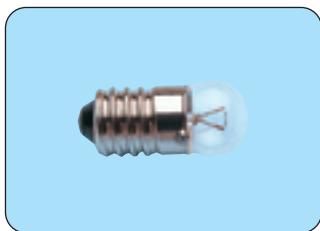

Echelle 1/Scale 1

Click Below To Order

Interlight Specialty Bulbs
1-800-743-0005
www.interlight.biz

CODE STOCK PART NUMBER	RÉFÉRENCE	VOLTS	CULOT BASE
125302	M 1020	3,8	E10

C2/44

POUR OPHTALMOSCOPE LUNEAU-SIMAY
For Ophthalmoscope

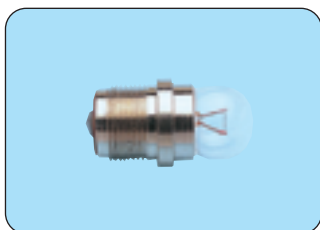

Echelle 1/Scale 1

CODE STOCK PART NUMBER	RÉFÉRENCE	VOLTS	AMPÈRE A	TYPE
125304	M 1019	3,8	0,44A	LUNEAU 12.36.76

C2/45

POUR RETINOSCOPE ET SKIASCOPE LUNEAU
For Retinoscope



Echelle 1/Scale 1

CODE STOCK PART NUMBER	RÉFÉRENCE	VOLTS	AMPÈRE A	TYPE
125306	M 6120	3,7	0,25A	LUNEAU 14.48.94

Third parties trademarks are mentioned in this catalogue when reference thereto is necessary to inform customers about the intended use of products sold by Orbitec. These trademarks remain the property of the manufacturers concerned.

C2/46

POUR LARYNGOSCOPE MC INTOSCH*
For Laryngoscope

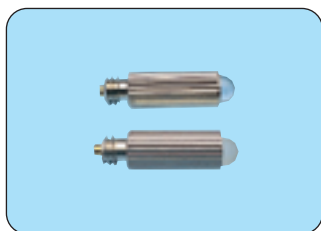

Echelle 1/Scale 1

Click Below To Order

Interlight Specialty Bulbs
1-800-743-0005
www.interlight.biz

CODE STOCK PART NUMBER	RÉFÉRENCE	VOLTS	VERRE GLASS
AVEC CONTACT COURT / Short contact			
125010	M 170	2,7	CLAIR/CLEAR
125000	M 170/D	2,7	DÉPOLI/FROSTED
AVEC CONTACT LONG / Long contact			
125030	M 170 L	2,7	CLAIR/CLEAR
125020	M 170 L/D	2,7	DÉPOLI/FROSTED

* Avec gaz krypton sur demande.

* Krypton gaz-filled on request.

C2/47

LAMPE POUR LARYNGOSCOPE MC INTOSH*
For Laryngoscope



Echelle 1/Scale 1

CODE STOCK PART NUMBER	RÉFÉRENCE	VOLTS	VERRE GLASS
AVEC ISOLANT ET CONTACT RESSORT / With spring			
125035	M 171	2,7	DÉPOLI/FROSTED
SANS ISOLANT ET SANS CONTACT RESSORT / Without spring			
125036	M 171/O	2,7	DÉPOLI/FROSTED

* Avec gaz krypton sur demande.

* Krypton gaz-filled on request.

C2/48

POUR PROSCOPE + RECTOSCOPE MORGAN
For Protoscope + Rectoscope



Echelle 1/Scale 1

CODE STOCK PART NUMBER	RÉFÉRENCE	VOLTS	VERRE GLASS
125163	MEA 24	3,5	CLAIR/CLEAR

Des marques de tiers sont citées dans le présent catalogue lorsque leur référence est nécessaire pour informer ses clients de la destination de produits commercialisés par Orbitec. Ces marques restent la propriété des fabricants concernés.

C2/49

POUR OPHTALMOSCOPE NATIONAL ELECTRIC
For Ophthalmoscope

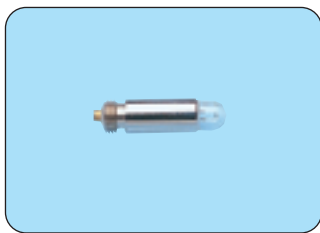

Echelle 1/Scale 1

Click Below To Order

Interlight Specialty Bulbs
1-800-743-0005
www.interlight.biz

CODE STOCK PART NUMBER	RÉFÉRENCE	VOLTS	VERRE GLASS
125273	M 160	2,5	CLAIR/CLEAR

C2/50

POUR LARYNGOSCOPE PENLON
For Laryngoscope



1



2



3

Echelle 1/Scale 1

CODE STOCK PART NUMBER	RÉFÉRENCE	VOLTS	VERRE GLASS	TYPE	PHOTO N° PICTURE N°
125040	M 172	2,7	CLAIR/CLEAR	55091	1
125041	M 457	2,5	CLAIR/CLEAR	55094	2
125150	M 092	2,5	DÉPOLIE/FROSTED	55092	3

C2/51

POUR BRONCHOSCOPE PILLING
For Bronchoscope

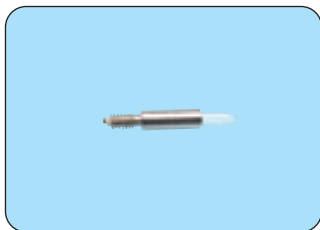

Echelle 1/Scale 1

CODE STOCK PART NUMBER	RÉFÉRENCE	VOLTS	VERRE GLASS
125260	MEP 10	3,5	CLAIR/CLEAR

Third parties trademarks are mentioned in this catalogue when reference thereto is necessary to inform customers about the intended use of products sold by Orbitec. These trademarks remain the property of the manufacturers concerned.

C2/52

POUR OTOSCOPE KEELER
For Otoscope

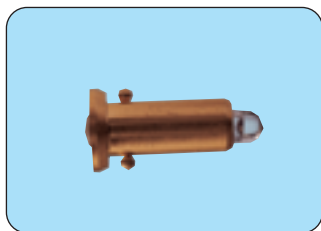

Echelle 1/Scale 1

Click Below To Order

Interlight Specialty Bulbs
1-800-743-0005
www.interlight.biz

CODE STOCK PART NUMBER	RÉFÉRENCE	VOLTS	TYPE	GAZ GAS
125211	P 5124	2,8	1015-P5124	TUNGSTENE 28
125213	P 5116	3,5	1015-P5116	HALOGÈNE

C2/53

POUR SKIASCOPE A SPOT KEELER
For Skiascope

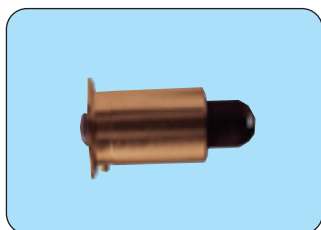

Echelle 1/Scale 1

CODE STOCK PART NUMBER	RÉFÉRENCE	VOLTS	TYPE	GAZ GAS
125204	P 5008	3,5	1013-P5008	SPOT/SPOT

C2/54

POUR SKIASCOPE ET OPHTALMOSCOPE DE POCHE KEELER
For pocket size Ophthalmoscope and Skiascope



Echelle 1/Scale 1

CODE STOCK PART NUMBER	RÉFÉRENCE	VOLTS	TYPE
125208*	P 5075	2,8	1013-P5075

* Vendu par unité d'emballage de 2 pcs.

* Sold by 2 pcs unit packing.

Des marques de tiers sont citées dans le présent catalogue lorsque leur référence est nécessaire pour informer ses clients de la destination de produits commercialisés par Orbitec. Ces marques restent la propriété des fabricants concernés.

C2/55

POUR LARYNGOSCOPE KEELER
For Laryngoscope

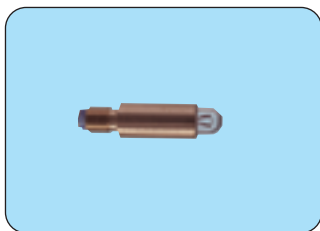

Echelle 1/Scale 1

Click Below To Order

Interlight Specialty Bulbs
1-800-743-0005
www.interlight.biz

CODE STOCK PART NUMBER	RÉFÉRENCE	VOLTS	TYPE	GAZ GAS
125206	P 5015	3	1018-P5015	

C2/56

POUR OPHTALMOSCOPE "SPECTACLE"
For Ophthalmoscope

CODE STOCK PART NUMBER	RÉFÉRENCE	VOLTS	TYPE	GAZ GAS
125330	P 5102	6	1012-P7002	HALOGÈNE

C2/57

POUR OPHTALMOSCOPE INDIRECT "VANTAGE & ALL PUPIL"
For Ophthalmoscope

CODE STOCK PART NUMBER	RÉFÉRENCE	VOLTS	TYPE	GAZ GAS
125325	P 5110	6	1012-P7003	HALOGÈNE

C2/58

POUR SKIASCOPE SPOT KEELER
For Skiascope



Echelle 1/Scale 1

CODE STOCK PART NUMBER	RÉFÉRENCE	VOLTS	TYPE	GAZ GAS
125326	P 5083	2,8	1013-P7000	HALOGÈNE
125327	P 5091	3,5	1013-P7001	HALOGÈNE

Third parties trademarks are mentioned in this catalogue when reference thereto is necessary to inform customers about the intended use of products sold by Orbitec. These trademarks remain the property of the manufacturers concerned.

C2/59

POUR SKIASCOPE A FENTE KEELER
For Skiascope



Echelle 1/Scale 1

Click Below To Order

Interlight Specialty Bulbs
1-800-743-0005
www.interlight.biz

CODE STOCK PART NUMBER	RÉFÉRENCE	VOLTS	TYPE	GAZ GAS
125328	P 5104	2,8	1013-P7002	HALOGÈNE
125329	P 5112	3,5	1013-P7003	HALOGÈNE

C2/60

POUR SKIASCOPE A FENTE PURVIS KEELER
For Skiascope

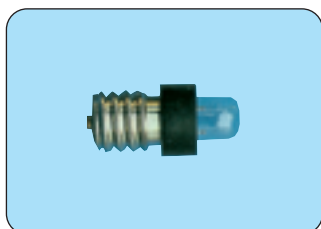

Echelle 1/Scale 1

CODE STOCK PART NUMBER	RÉFÉRENCE	VOLTS	TYPE	GAZ GAS
125331	P 5120	2,7	1013-P7004	TUNGSTENE
125332	P 5139	3,5	1013-P7005	

C2/61

POUR SKIASCOPE SPOT VISTA KEELER
For Skiascope



Echelle 1/Scale 1

CODE STOCK PART NUMBER	RÉFÉRENCE	VOLTS	TYPE	GAZ GAS
125333	P 5155	2,8	1013-P7006	HALOGÈNE
125334	P 5163	3,5	1013-P7007	HALOGÈNE

Des marques de tiers sont citées dans le présent catalogue lorsque leur référence est nécessaire pour informer ses clients de la destination de produits commercialisés par Orbitec. Ces marques restent la propriété des fabricants concernés.



C2/62

POUR SKIASCOPE A FENTE VISTA/PURVIS KEELER

For Skiascope



Echelle 1/Scale 1

Click Below To Order

Interlight Specialty Bulbs
1-800-743-0005
www.interlight.biz

CODE STOCK PART NUMBER	RÉFÉRENCE	VOLTS	TYPE	GAZ GAS
125335	P 5171	2,8	1013-P7008	HALOGÈNE
125336	P 5198	3,5	1013-P7009	HALOGÈNE

C2/63

POUR OPHTALMOSCOPE DIRECT VISTA ET DE POCHE

For Ophthalmoscope



1



2

Echelle 1/Scale 1

Les ampoules "Halogène 28" ont des enveloppes OR et une base bleue/*with gold body and blue base.*

Les ampoules "Halogène 35" ont des enveloppes Or et une base rouge/*with gold body and red base.*

Les ampoules "Tungstène 28" ont des enveloppes Argent et une base bleue/*with silver body and blue base.*

CODE STOCK PART NUMBER	RÉFÉRENCE	VOLTS	TYPE	GAZ GAS	UNITÉ D'EMBALLAGE BOX.	PHOTO N° PICTURE N°
125207	P 5047	2,8	1011-P7050	HALOGÈNE 28	2	1
125217	P 5039	2,8	1011-P5039	TUNGSTÈNE 28	1	2
125218	P 5223	2,8	1011-P7042	HALOGÈNE 28	2	2
125219	P 5055	3,5	1011-P7034	HALOGÈNE 35	2	2

C2/64

POUR OPHTALMOSCOPE INDIRECT (FISON) KEELER

For Ophthalmoscope



Echelle 1/Scale 1

CODE STOCK PART NUMBER	RÉFÉRENCE	VOLTS	TYPE	GAZ GAS
125215	P 5006	6	1012-P7000	(18 WATTS) NON HALOGÈNE
125216	P 5014	6	1012-P7001	HALOGÈNE

Third parties trademarks are mentioned in this catalogue when reference thereto is necessary to inform customers about the intended use of products sold by Orbitec. These trademarks remain the property of the manufacturers concerned.

C2/65

POUR OTOSCOPE RIESTER

For Otoscope



Echelle 1/Scale 1

Click Below To Order

Interlight Specialty Bulbs
1-800-743-0005
www.interlight.biz

CODE STOCK PART NUMBER	RÉFÉRENCE	VOLTS	VERRE GLASS	TYPE	GAZ GAS
125271	M 114	2,7	CLAIR/CLEAR	3900	HALOGÈNE
125286	MK 421	2,7	CLAIR/CLEAR	10421	KRYPTON

C2/66

POUR OPHTALMOSCOPE VARIFOCAL/RIESTER

For Ophthalmoscope



Echelle 1/Scale 1

CODE STOCK PART NUMBER	RÉFÉRENCE	VOLTS	VERRE GLASS	TYPE
125111	M 100/2	2,5	CLAIR/CLEAR	3950

C2/67

POUR OTOSCOPE, SPECULUM RIESTER

For Otoscope

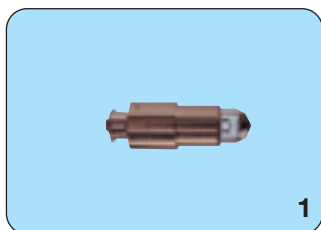

1



2

Echelle 1/Scale 1

CODE STOCK PART NUMBER	RÉFÉRENCE	VOLTS	VERRE GLASS	TYPE	PHOTO N° PICTURE N°
125281	MH 600	2,5	CLAIR/CLEAR	10600	1
125282	MH 601	3,5	CLAIR/CLEAR	10601	2

Des marques de tiers sont citées dans le présent catalogue lorsque leur référence est nécessaire pour informer ses clients de la destination de produits commercialisés par Orbitec. Ces marques restent la propriété des fabricants concernés.



C2/68

POUR LARYNGOSCOPE A MAIN ET TOPLIGHT RIESTER

For Laryngoscope

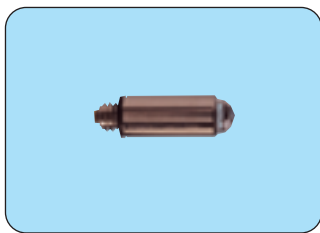

Echelle 1/Scale 1

Click Below To Order

Interlight Specialty Bulbs
1-800-743-0005
www.interlight.biz

CODE STOCK PART NUMBER	RÉFÉRENCE	VOLTS	VERRE GLASS	TYPE
125283	MH 430	2,5	CLAIR/CLEAR	11430

C2/69

POUR OPHTALMOSCOPE RIESTER ET RI-DERMA

For Ophthalmoscope



1

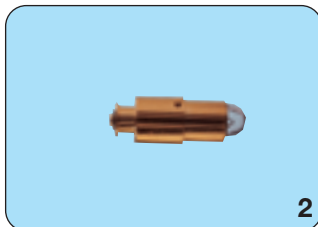

2

Echelle 1/Scale 1

CODE STOCK PART NUMBER	RÉFÉRENCE	VOLTS	VERRE GLASS	TYPE	PHOTO N° PICTURE N°
125284	MH 605	2,5	CLAIR/CLEAR	10605	1
125285	MH 606	3,5	CLAIR/CLEAR	10606	2

C2/70

POUR OPHTALMOSCOPE MAY/RIESTER

For Ophthalmoscope

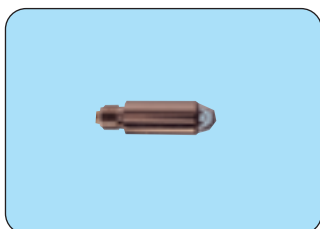

Echelle 1/Scale 1

CODE STOCK PART NUMBER	RÉFÉRENCE	VOLTS	VERRE GLASS	TYPE
125266	M 400	2,7	CLAIR/CLEAR	10424

Third parties trademarks are mentioned in this catalogue when reference thereto is necessary to inform customers about the intended use of products sold by Orbitec. These trademarks remain the property of the manufacturers concerned.

C2/71

POUR OTOSCOPE TUTTLINGER

For Otoscope

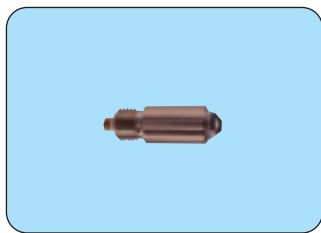

Echelle 1/Scale 1

Click Below To Order

Interlight Specialty Bulbs
1-800-743-0005
www.interlight.biz

CODE STOCK PART NUMBER	RÉFÉRENCE	VOLTS	VERRE GLASS
125107	M 42 B	2,7	CLAIR/CLEAR
125108	M 42 C	2,5	CLAIR/CLEAR

C2/72

POUR ANALSPECULUM DR ROSCHKE



Echelle 1/Scale 1

CODE STOCK PART NUMBER	RÉFÉRENCE	VOLTS	VERRE GLASS
125162	M 168	3,8	CLAIR/CLEAR

C2/73

POUR LARYNGOSCOPE SCHARRAS

For Laryngoscope



Echelle 1/Scale 1

CODE STOCK PART NUMBER	RÉFÉRENCE	VOLTS	VERRE GLASS
125037	M 169	2,5	CLAIR/CLEAR

Des marques de tiers sont citées dans le présent catalogue lorsque leur référence est nécessaire pour informer ses clients de la destination de produits commercialisés par Orbitec. Ces marques restent la propriété des fabricants concernés.

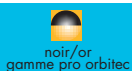

C2/74

POUR ÉCLAIREUR FRONTAL STORZ
For head light



Echelle 1/Scale 1

Click Below To Order

Interlight Specialty Bulbs
1-800-743-0005
www.interlight.biz

CODE STOCK PART NUMBER	RÉFÉRENCE	VOLTS	AMPÈRE/ WATTS	CULOT BASE
018970	OR 9059	6	1A/6W	E10

C2/75

POUR LARYNGOSCOPE STORZ
For Laryngoscope



Echelle 1/Scale 1

CODE STOCK PART NUMBER	RÉFÉRENCE	VOLTS	VERRE GLASS
124995	M 101	2,5	CLAIR/CLEAR

C2/76

POUR LARYNGOSCOPE WELCH-ALLYN
For Laryngoscope

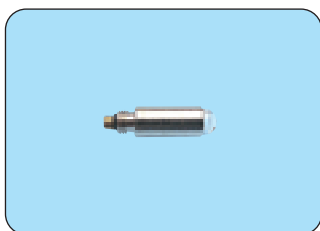

Echelle 1/Scale 1

CODE STOCK PART NUMBER	RÉFÉRENCE	VOLTS	VERRE GLASS	TYPE
POUR ENFANTS				
125100	MEWA1A	2,5	CLAIR/CLEAR	00100
125101	MEWA1A/D	2,5	DÉPOLI/FROSTED	00100

Third parties trademarks are mentioned in this catalogue when reference thereto is necessary to inform customers about the intended use of products sold by Orbitec. These trademarks remain the property of the manufacturers concerned.

C2/77

POUR OTOSCOPE, ANUSCOPE ET ECLAIREUR WELCH ALLYN

For Otoscope, Anuscope and "WA" Illuminator



Echelle 1/Scale 1

Click Below To Order

Interlight Specialty Bulbs
1-800-743-0005
www.interlight.biz

CODE STOCK PART NUMBER	RÉFÉRENCE	VOLTS	VERRE GLASS	TYPE	GAZ GAS
125114	MEWA 2	2,7	CLAIR/CLEAR	00200	AVEC JOINT/WITH RING
125125	MEWA 002	2,7	CLAIR/CLEAR	00200	SANS JOINT/WITHOUT RING

C2/78

POUR OPHTHALMOSCOPE ET SIGMOÏDOSCOPE WELCH ALLYN

For Ophthalmoscope

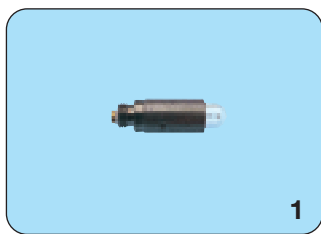

1

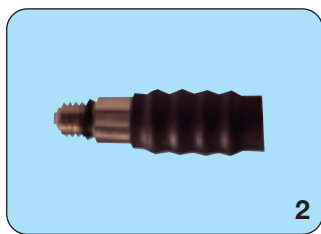

2

Echelle 1/Scale 1

CODE STOCK PART NUMBER	RÉFÉRENCE	VOLTS	VERRE GLASS	TYPE	FIGURE DRAWING N°
125117	MEWA 6	2,5	CLAIR/CLEAR	00600	1
125130	MEWA 78	6	-	07800	2

C2/79

POUR OPHTHALMOSCOPE ET RETINOSCOPE WELCH ALLYN

For Ophthalmoscope and Retinoscope

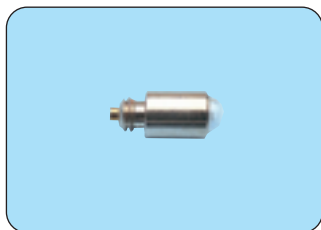

Echelle 1/Scale 1

CODE STOCK PART NUMBER	RÉFÉRENCE	VOLTS	VERRE GLASS	TYPE
125118	MEWA 9	2,5	CLAIR/CLEAR	00900

Des marques de tiers sont citées dans le présent catalogue lorsque leur référence est nécessaire pour informer ses clients de la destination de produits commercialisés par Orbitec. Ces marques restent la propriété des fabricants concernés.



C2/80

POUR TRANSILLUMINATEUR WELCH ALLYN

For Illuminator



Echelle 1/Scale 1

Click Below To Order

Interlight Specialty Bulbs
1-800-743-0005
www.interlight.biz

CODE STOCK PART NUMBER	RÉFÉRENCE	VOLTS	VERRE GLASS	TYPE
125238	MEWA 10	2,5	CLAIR/CLEAR	001000

C2/81

POUR OPHTALMOSCOPE WELCH ALLYN

For Ophthalmoscope



Echelle 1/Scale 1

CODE STOCK PART NUMBER	RÉFÉRENCE	VOLTS	VERRE GLASS	TYPE
125239	MEWA 23	2,5	CLAIR/CLEAR	02300

C2/82

LAMPE FRONTALE WELCH ALLYN

For head light



Echelle 1/Scale 1

CODE STOCK PART NUMBER	RÉFÉRENCE	VOLTS	VERRE GLASS	TYPE
125119	MEWA 25	6	CLAIR/CLEAR	02500

Third parties trademarks are mentioned in this catalogue when reference thereto is necessary to inform customers about the intended use of products sold by Orbitec. These trademarks remain the property of the manufacturers concerned.

C2/83

LAMPE FRONTALE HALOGENE WELCH ALLYN

For halogen head light



Echelle 1/Scale 1

Click Below To Order

Interlight Specialty Bulbs
1-800-743-0005
www.interlight.biz

CODE STOCK PART NUMBER	RÉFÉRENCE	VOLTS	VERRE GLASS	TYPE
125240	MEWA 26	6	CLAIR/CLEAR	02600

C2/84

POUR OPHTHALMOSCOPE ET RETINOSCOPE WELCH ALLYN

For Ophthalmoscope and Retinoscope



1

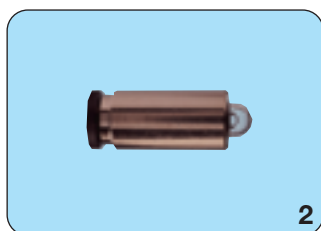

2

Echelle 1/Scale 1

CODE STOCK PART NUMBER	RÉFÉRENCE	VOLTS	VERRE GLASS	TYPE	PHOTO N° PICTURE N°
125835	LT 030000	3,5	CLAIR/CLEAR	03000	1
125832	MEWA 49	3,5	CLAIR/CLEAR	04900	2

C2/85

POUR OPHTHALMOSCOPE WELCH ALLYN

For Ophthalmoscope



Echelle 1/Scale 1

CODE STOCK PART NUMBER	RÉFÉRENCE	VOLTS	VERRE GLASS	TYPE
125121	MEWA 28	-	CLAIR/CLEAR	02800

Des marques de tiers sont citées dans le présent catalogue lorsque leur référence est nécessaire pour informer ses clients de la destination de produits commercialisés par Orbitec. Ces marques restent la propriété des fabricants concernés.

C2/86

POUR OTOSCOPE ET TRANSILLUMINATEUR WELCH ALLYN

For Otoscope and Illuminator



Echelle 1/Scale 1

Click Below To Order

Interlight Specialty Bulbs
1-800-743-0005
www.interlight.biz

CODE STOCK PART NUMBER	RÉFÉRENCE	VOLTS	VERRE GLASS	TYPE
125126	MEWA 031	3,5	CLAIR/CLEAR	03100

C2/87

POUR OPHTALMOSCOPE WELCH ALLYN

For Ophthalmoscope



Echelle 1/Scale 1

CODE STOCK PART NUMBER	RÉFÉRENCE	VOLTS	VERRE GLASS	TYPE
125128	MEWA 033	2,5	CLAIR/CLEAR	03300/02100

C2/88

POUR OTOSCOPE ET ECLAIREUR WELCH ALLYN

For Otoscope and Wa Illuminator



1



2

Echelle 1/Scale 1

CODE STOCK PART NUMBER	RÉFÉRENCE	VOLTS	VERRE GLASS	TYPE	PHOTO N° PICTURE N°
125127	MEWA 34	2,5	CLAIR/CLEAR	03400	1
125337	MEWA 085	3,6	CLAIR/CLEAR	08500	2

Third parties trademarks are mentioned in this catalogue when reference thereto is necessary to inform customers about the intended use of products sold by Orbitec. These trademarks remain the property of the manufacturers concerned.

C2/89

POUR RETINOSCOPE WELCH ALLYN
For Retinoscope

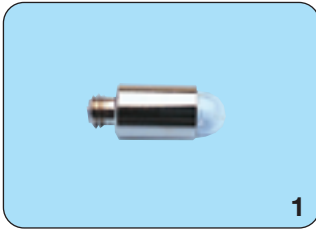

1

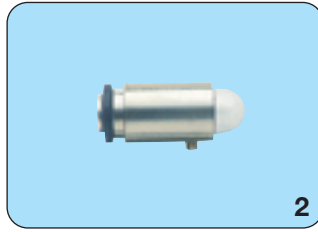

2

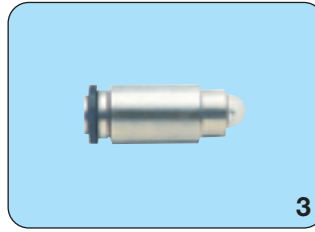

3

Click Below To Order

Interlight Specialty Bulbs
1-800-743-0005
www.interlight.biz

Echelle 1/Scale 1

CODE STOCK PART NUMBER	RÉFÉRENCE	VOLTS	VERRE GLASS	TYPE	PHOTO N° PICTURE N°
125241	MEWA 37	3,5	CLAIR/CLEAR	03700	1
125251	MEWA 082	3,5	-	08200	2
125338	MEWA 083	3,5	CLAIR/CLEAR	08300	3
125339	MEWA 084	2,5	-	08400	

C2/90

POUR OPHTALMOSCOPE WELCH ALLYN
For Ophthalmoscope



Echelle 1/Scale 1

Click Below To Order

Interlight Specialty Bulbs
1-800-743-0005
www.interlight.biz

CODE STOCK PART NUMBER	RÉFÉRENCE	VOLTS	VERRE GLASS	TYPE
125131	MEWA 039	-	CLAIR/CLEAR	03900

C2/91

POUR PENLITE WELCH ALLYN



Echelle 1/Scale 1

CODE STOCK PART NUMBER	RÉFÉRENCE	VOLTS	VERRE GLASS	TYPE
125133	MEWA 76	6	CLAIR/CLEAR	07600

Des marques de tiers sont citées dans le présent catalogue lorsque leur référence est nécessaire pour informer ses clients de la destination de produits commercialisés par Orbitec. Ces marques restent la propriété des fabricants concernés.

C2/92

POUR LAMPE D'EXAMEN WELCH ALLYN
For Diagnostic Lamp



Echelle 1/Scale 1

Click Below To Order

Interlight Specialty Bulbs
1-800-743-0005
www.interlight.biz

CODE STOCK PART NUMBER	RÉFÉRENCE	VOLTS	VERRE GLASS	TYPE
125120	MEWA41	14,5	CLAIR/CLEAR	04100
125242	MEWA61	14,5	CLAIR/CLEAR	06100

C2/93

POUR RETINOSCOPE WELCH ALLYN
For Retinoscope



1



2

Echelle 1/Scale 1

CODE STOCK PART NUMBER	RÉFÉRENCE	VOLTS	VERRE GLASS	TYPE	PHOTO N° PICTURE N°
125830	LT 044000	2,5	CLAIR/CLEAR	04400/04300	1
125243	MEWA 45	3,5	CLAIR/CLEAR	04500	2

C2/94

POUR RETINOSCOPE WELCH ALLYN
For Retinoscope



1



2

Echelle 1/Scale 1

CODE STOCK PART NUMBER	RÉFÉRENCE	VOLTS	VERRE GLASS	TYPE	PHOTO N° PICTURE N°
125244	MEWA 46	3,5	CLAIR/CLEAR	04600	1
125340	MEWA 072	2,5	-	07200	2

Third parties trademarks are mentioned in this catalogue when reference thereto is necessary to inform customers about the intended use of products sold by Orbitec. These trademarks remain the property of the manufacturers concerned.

C2/95

POUR LARYNGOSCOPE WELCH ALLYN
For Laryngoscope

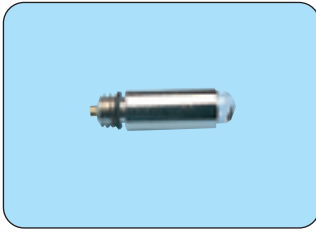

Echelle 1/Scale 1

Click Below To Order

Interlight Specialty Bulbs
1-800-743-0005
www.interlight.biz

CODE STOCK PART NUMBER	RÉFÉRENCE	VOLTS	VERRE GLASS	TYPE
LARYNGOSCOPE À MAIN				
125124	MEWA 060	-	CLAIR/CLEAR	06000

C2/96

POUR AUDIOSCOPE WELCH ALLYN
For Audioscope

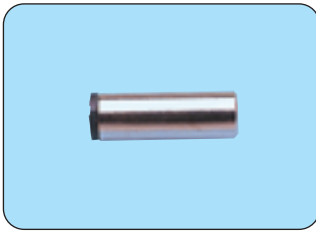

Echelle 1/Scale 1

CODE STOCK PART NUMBER	RÉFÉRENCE	VOLTS	VERRE GLASS	TYPE
125247	MEWA 62	3,5	CLAIR/CLEAR	06200

C2/97

POUR LARYNGOSCOPE A FIBRE OPTIQUE WELCH ALLYN
For Fiber Optic Laryngoscope



Echelle 1/Scale 1

CODE STOCK PART NUMBER	RÉFÉRENCE	VOLTS	VERRE GLASS	TYPE
125248	MEWA 804	2,5	CLAIR/CLEAR	KRYPTON

Des marques de tiers sont citées dans le présent catalogue lorsque leur référence est nécessaire pour informer ses clients de la destination de produits commercialisés par Orbitec. Ces marques restent la propriété des fabricants concernés.

C2/98

POUR LARYNGOSCOPE ET OTOSCOPE WELCH ALLYN

For Laryngoscope and Otoscope

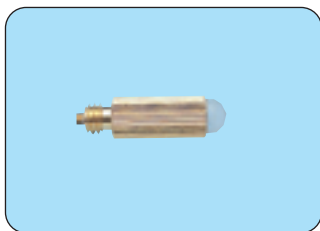

Echelle 1/Scale 1

Click Below To Order

Interlight Specialty Bulbs
1-800-743-0005
www.interlight.biz

CODE STOCK PART NUMBER	RÉFÉRENCE	VOLTS	VERRE GLASS	TYPE
125249	MEWA 815	2,7	CLAIR/CLEAR	KRYPTON

C2/99

LAMPE TYPE "N" HALOGENE WELCH ALLYN

"N" Halogen Type



Echelle 1/Scale 1

CODE STOCK PART NUMBER	RÉFÉRENCE	VOLTS	VERRE GLASS	TYPE
125831	LT 034000	2,5	CLAIR/CLEAR	WA34

C2/100

LAMPE TYPE "Q" HALOGENE WELCH ALLYN

"Q" Halogen Type



Echelle 1/Scale 1

CODE STOCK PART NUMBER	RÉFÉRENCE	VOLTS	DIAMÈTRE (MM)	AMPÈRE
125810	LT 998087 - 8	2,6	4,7	0,85
125840	LT 998087 - 5	3,5	4,6	0,72
125795	LT 998319 - 14	4,5	6,17	0,89
125845	LT 998085 - 6	5	6,17	0,80
125800	LT 998319 - 5	5	7,18	1,6
125798	LT 998319 - 9	6	6,17	1,3
125788	LT 998085 - 8	6	7,11	0,70

Third parties trademarks are mentioned in this catalogue when reference thereto is necessary to inform customers about the intended use of products sold by Orbitec. These trademarks remain the property of the manufacturers concerned.

C2/101

TYPE "R" HALOGÈNE WELCH ALLYN
"R" Halogen Type

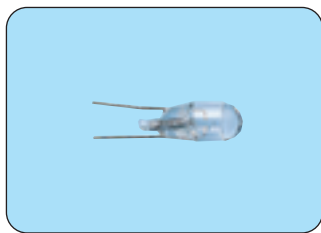

Echelle 1/Scale 1

Click Below To Order

Interlight Specialty Bulbs
1-800-743-0005
www.interlight.biz

CODE STOCK PART NUMBER	RÉFÉRENCE	VOLTS	VERRE GLASS	TYPE
125850	LT 01076	2,5	A LENTILLE/WITH LENS	01076
125852	LT 01085	3,65	CLAIR/CLEAR	01085

C2/102

POUR OTOSCOPE WELCH ALLYN ET HEINE
For Otoscope



Echelle 1/Scale 1

CODE STOCK PART NUMBER	RÉFÉRENCE	VOLTS	TYPE
125115	MEWA 3	2,2	01300/03600

C2/103

POUR LENSMETER TOPCON

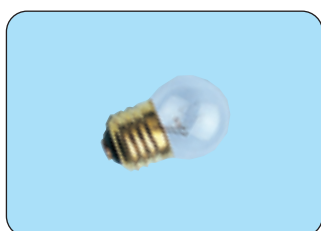

Echelle 1/Scale 1

CODE STOCK PART NUMBER	RÉFÉRENCE	VOLTS	WATTS	DIMENSIONS D x L (MM)	VERRE GLASS	CULOT BASE
124603	M 1204	12	6	15 x 30	CLAIR/CLEAR	E10
124600	LT 1014	230	15	40 x 60	CLAIR/CLEAR	E27
124601	LT 1015	230	15	35 x 55	DÉPOLI/FROSTED	E27
124602	LT 1013	230	15	30 x 60	CLAIR/CLEAR	E27

Des marques de tiers sont citées dans le présent catalogue lorsque leur référence est nécessaire pour informer ses clients de la destination de produits commercialisés par Orbitec. Ces marques restent la propriété des fabricants concernés.

C2/104

POUR ECLAIRAGE OPERATOIRE TYPE "SKYLUX"

For operating room lighting equipment

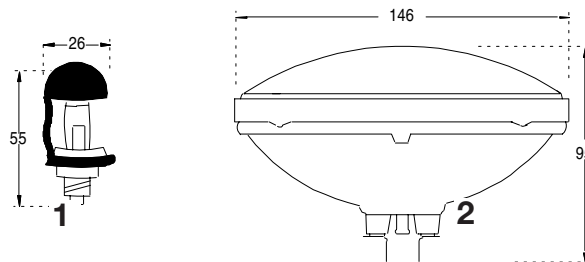

CODE STOCK PART NUMBER	RÉFÉRENCE	VOLTS	WATTS	DIMENSIONS D x L (MM)	CULOT BASE	FIGURE DRAWING N°
130060	H 145 B3 B	24	40	146 x 95	PAR 46	2
130064	H 422435	24	35	26 x 55	E 11	1
130065	H 422440	24	40	26 x 55	E 11	1
130066	H 422450	24	50	26 x 55	E 11	1

Click Below To Order

Interlight Specialty Bulbs
1-800-743-0005
www.interlight.biz

C2/105

POUR BLOC OPERATOIRE TYPE "AMSCO"

For operating room lighting equipment



CODE STOCK PART NUMBER	RÉFÉRENCE	VOLTS	WATTS	DIMENSIONS D x L (MM)	CULOT BASE	TYPE
130766	P 25/24150	24	150	80 x 118	E 26	DÉPOLIE/FROSTED
130765	P 25/25B120	120	150	80 x 118	E 26	CALOTTE ARGENTÉE/SILVER
130762	P 150/P2510	120	150	80 x 118	E 26	DÉPOLIE/FROSTED
130761	P 25/33235	33	235	13 x 65	GY 9,5	DÉPOLIE/FROSTED
125341	P 25/22220	22	220	13 x 65	GY 9,5	CLAIR/CLEAR
125342	P 25/2250	22	50	-	MR16	-

Third parties trademarks are mentioned in this catalogue when reference thereto is necessary to inform customers about the intended use of products sold by Orbitec. These trademarks remain the property of the manufacturers concerned.

C2/106

E27/E40 POUR ECLAIRAGE OPERATOIRE TYPE "BBT"

For operating room lighting



Click Below To Order

Interlight Specialty Bulbs
1-800-743-0005
www.interlight.biz

CODE STOCK PART NUMBER	RÉFÉRENCE	VOLTS	WATTS	CULOT BASE	DIMENSIONS D x L (MM)	RÉFÉRENCE DE L'APPAREIL EQUIPMENT TYPE	PHOTO N°
130018	H 295033	24	45	E27	40 x 62	OPTOTAL	1
130016	H 295133	24	150	E27	80 x 160	S7	3
130012	H 307710	24	120	E40	70 x 110	-	2
130010	H 307970	24	400	E40	80 x 170	SUPER SCIALYTIQUE	4
130006	H 307590	24-24	150-150	E40	80 x 170	S9-S7	4
130004	H 307592	24-24	250-250	E40	80 x 170	OPTOTAL	4
130008	H 307553	115-24	250-100	E40	80 x 170	OPTOTAL	4

C2/107

BA21D/B22D 3 ERGOTS 3 PINS POUR ECLAIRAGE OPERATOIRE TYPE "BBT"

For operating room lighting

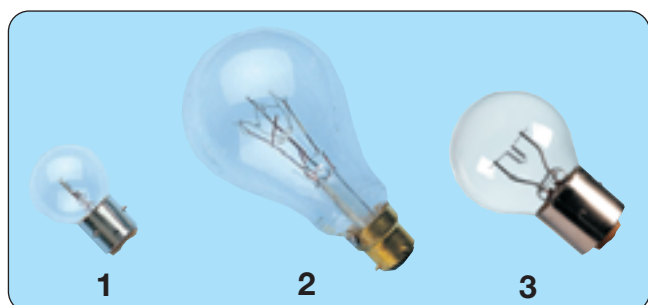

CODE STOCK PART NUMBER	RÉFÉRENCE	VOLTS	WATTS	CULOT BASE	DIMENSIONS D x L (MM)	RÉFÉRENCE DE L'APPAREIL EQUIPMENT TYPE	PHOTO N°
112900	P 6144 F	16	8 A	BA21D	40 x 63	-	3
130028	H 273812	24	30 W	BA21D	40 x 60	CFM PLURALUX VIDÉOLUX	1
130030	H 273820	24	45 W	BA21D	40 x 60	OPTOTAL	1
130038	H 273400	115-12	150-75 W	B22D-3	80 x 140	S4	2
130040	H 273451	225-12	150-75 W	B22D-3	80 x 140	-	2
130032	H 276091	225	150 W	B22D-3	80 x 140	S4	2

Des marques de tiers sont citées dans le présent catalogue lorsque leur référence est nécessaire pour informer ses clients de la destination de produits commercialisés par Orbitec. Ces marques restent la propriété des fabricants concernés.

SPECIALES ET TECHNIQUES
SPECIAL LAMPS

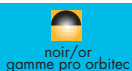

C2/108

B15D TUBE HALOGENE POUR ECLAIRAGE OPERATOIRE

Halogen tube for operating room

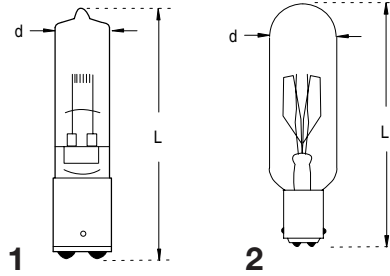

Click Below To Order

Interlight Specialty Bulbs
1-800-743-0005
www.interlight.biz

CODE STOCK PART NUMBER	RÉFÉRENCE	VOLTS	CODE ANSI	WATTS	FLUX LUMENS	DIMENSIONS D x L (MM)	DURÉE DE VIE AC LIFE	FIGURE N° DRAWING N°
130542	H 61670	24		150	5 000	14 x 65	50	1
131403	H 61671	230	CHY	50	650	26 x 79	50	2
131404	H 61672	230	CJX	100	1 650	26 x 79	50	2

C2/109

B15D SPHERIQUE POUR ECLAIRAGE OPERATOIRE TYPE "APOLLON"

For operating room lighting

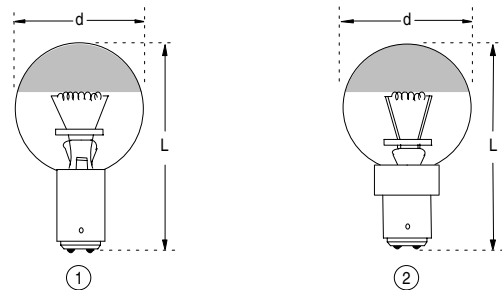

CODE STOCK PART NUMBER	RÉFÉRENCE	VOLTS	WATTS	DIMENSIONS D x L (MM)	FIGURE N° DRAWING N°
130767	H 003700	24	30	40 x 60	1
130751	H 002435	24	35	50 x 76	2
130771	H 003706	24	40	50 x 76	2
130769	H 003701	24	50	50 x 76	2

Third parties trademarks are mentioned in this catalogue when reference thereto is necessary to inform customers about the intended use of products sold by Orbitec. These trademarks remain the property of the manufacturers concerned.

SPECIALLES ET TECHNIQUES
SPECIAL LAMPS

Click Below To Order

Interlight Specialty Bulbs
1-800-743-0005
www.interlight.biz

BX22D POUR ECLAIRAGE OPERATOIRE TYPE "HANAULUX"

Operating room

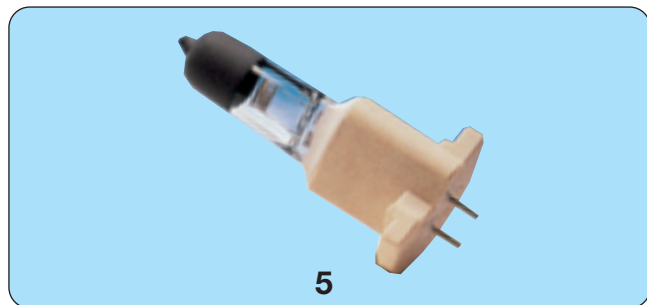
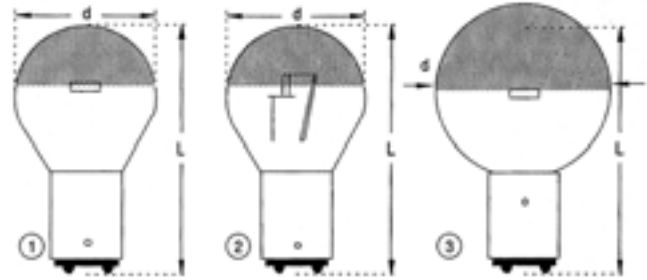

CODE STOCK PART NUMBER	RÉFÉRENCE	VOLTS	WATTS	CULOT BASE	DIMENSIONS D x L (MM)	VERRE GLASS BULB	TYPE	PHOTO N°
131816	H 151225	12	25	B15D	40 x 63	CLAIR ARGENTÉ (1)	016191	1
131826	H 151240	12	40	B15D	40 x 63	CLAIR ARGENTÉ (1)	-	1
131818	H 152425	24	25	B15D	40 x 63	CLAIR ARGENTÉ (1)	016164	1
131820	H 152440*	24	40	B15D	40 x 63	CLAIR ARGENTÉ (1)	018550	2
130772	H 111030	110	30	B15D	40 x 63	CLAIR ARGENTÉ (1)	016170	1
131827	H 112040	120	40	B15D	45 x 75	CLAIR ARGENTÉ (1)	016534	1
130753	H 112530	125	30	B15D	40 x 63	CLAIR ARGENTÉ (1)	016238	1
130746	H 228440 C	24	40	BX22D	50 x 80	CLAIR ARGENTÉ (1)	016544	3
131828	H 222440 D	24	40	BX22D	50 x 80	CLAIR ARGENTÉ (1)	018306	3
131810	H 222450	24	50	BX22D	50 x 80	CLAIR ARGENTÉ (1)	016678	3
131823	HN 016678	24	50	BX22D	50 x 80	CLAIR ARGENTÉ (1)	016678	3
131829	H 225050	50	50	BX22D	50 x 80	CLAIR ARGENTÉ (1)	016685	3
130752	H 211050	110	50	BX22D	50 x 80	CLAIR ARGENTÉ (1)	016679	3
131830	H 212050	120	50	BX22D	50 x 80	DÉPOLI ARGENTÉ (2)	019190/016423	3
130755	H 212550	125	50	BX22D	50 x 80	DÉPOLI ARGENTÉ (2)	016578	3
131814	H 22050 D	220	50	BX22D	50 x 80	DÉPOLI ARGENTÉ (2)	018250/019188	3
131825	H 24050 C	240	50	BX22D	50 x 80	CLAIR ARGENTÉ (1)	018253/018251	3
131831	H 225051	250	50	BX22D	50 x 80	DÉPOLI ARGENTÉ (2)	018252-253/019189	3
130756	H 30050	24	50	SPECIAL	-	-	H053026 BLUE 30	4
130781	H 80130	21,5	130	SPECIAL	-	-	H080130 BLUE 80	5
130768	H 13090	22,8	90	SPECIAL	-	-	H053198 BLUE 90	5

* Filament vertical/Vertical filament

(1) Clear/Silver top
(2) Frosted/Silver top

Des marques de tiers sont citées dans le présent catalogue lorsque leur référence est nécessaire pour informer ses clients de la destination de produits commercialisés par Orbitec. Ces marques restent la propriété des fabricants concernés.

SPECIALES ET TECHNIQUES
SPECIAL LAMPS

C2/111

GZ 6,35 - G 6,35 - R7S POUR ECLAIRAGE OPERATOIRE TYPE "HANAULUX"

For operating room

Click Below To Order

Interlight Specialty Bulbs
1-800-743-0005
www.interlight.biz

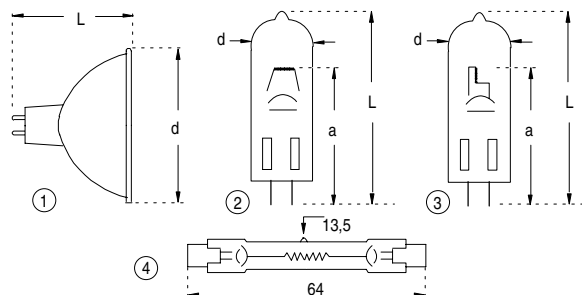

CODE STOCK PART NUMBER	RÉFÉRENCE	VOLTS	WATTS	CULOT BASE	DIMENSIONS D x L (MM)	VERRE GLASS	TYPE	FIGURE N° DRAWING N°
130269	H 164627	12	100	GZ6,35	50 x 40	A MIROIR DICHROÏQUE (A)	018565	1
130745	H 012100	12	100	GZ6,35	50 x 32,5	A MIROIR + FILS (B)	04653	1
130747	H 122840	22,8	40	G6,35	10,5 x 42	A FILAMENT HORIZONTAL	018769	2
130749	H 122850	22,8	50	G6,35	10,5 x 42	A FILAMENT HORIZONTAL	018566	2
130748	H 122850 AX	22,8	50	G6,35	10,5 x 42	FILAMENT AXIAL/AVEC OUTIL (C)	56115282	3
130754	H 164650	22,8	50	G6,35	11 x 33	FILAMENT AXIAL/SANS OUTIL (D)		3
130245	H 65906	22,8	150	G6,35	13,5 x 50	A FILAMENT AXIAL		3
130750	H 122875	22,8	75	R7S	13,5 x 64	R7S	018366	4

(A) Dichroic mirror.

(B) Dichroic mirror end - wires.

(C) Lamp with extracting tool.

(D) Without tool.

C2/112

POUR BLOC OPERATOIRE TYPE "MARTIN/BERCHTOLD"

For operating room

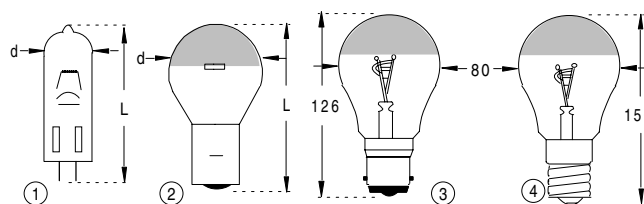

CODE STOCK PART NUMBER	RÉFÉRENCE	VOLTS	WATTS	CULOT BASE	DIMENSIONS D x L (MM)	TYPE	FIGURE N° DRAWING N°
130192	H 164602	12	50	G6,35	11,5 x 46	CZ 955-12	1
130214	H 164633	15	150	G6,35	11,5 x 44	80-990-00	1
130223	H 164655	24	250	G6,35	13,5 x 55	80-990-01	1
130748	H 122850 AX	22,8	50	G6,35	11 x 42	86-903-00	1
130245	H 65906 AX	22,8	150	G6,35	13,5 x 50	CZ 906-24	1
130191	H 164638	24	100	G6,35	13 x 50	88-905-24	1
131822	H 65905 AX	24	120	G6,35	11 x 44	86-905-00	1
130218	H 164642	24	150	G6,35	13,5 x 50	86-907-00/01	1
130222	H 164657	24	250	G6,35	13,5 x 50	86-910-00/01	1
131821	H 52425	24	25	BA20 D	40 x 70	86-950-00	2
130593	H 54250	24	50	BA20 D	40 x 70	86-950-01 - C7 916-04	2
130001	H 65690	24	50/50	B22 D	80 x 126	88-914-02	3
130003	H 65975	24	75/75	E27	80 x 150	88-912-02	4
130005	H 65100	24	100/100	E27	90 x 170	88-910-02	4

Pour autres lampes Berchtold/Martin nous consulter.

For other types please consult us.

Third parties trademarks are mentioned in this catalogue when reference thereto is necessary to inform customers about the intended use of products sold by Orbitec. These trademarks remain the property of the manufacturers concerned.

C2/113

POUR BLOC OPERATOIRE - SCIALYTIQUES DE TYPE ALLEMAND
For operating room-german type

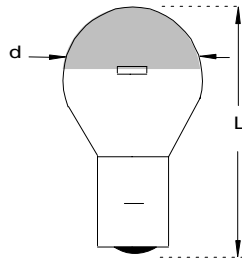
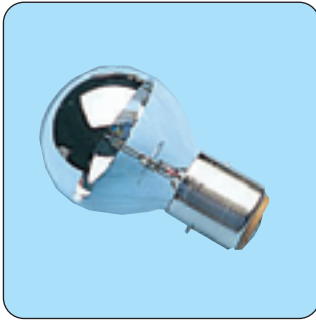

Click Below To Order

Interlight Specialty Bulbs
1-800-743-0005
www.interlight.biz

CODE STOCK PART NUMBER	RÉFÉRENCE	VOLTS	WATTS	CULOT BASE	DIMENSIONS D x L (MM)	TYPE
131837	H51260	12	60	BA20D	40 x 64	CALOTTE ARGENTÉE/TOP SILVER MIRROR
131821	H52425	24	25	BA20D	40 x 70	CALOTTE ARGENTÉE/TOP SILVER MIRROR
130591	H55023	24	50	BA20D	40 x 70	CLAIR/CLEAR
130593	H54250	24	50	BA20D	40 x 70	CALOTTE ARGENTÉE/TOP SILVER MIRROR
130597	H55024	24	75	BA20D	40 x 70	CLAIR/CLEAR
130595	H55025	24	60	BA20D	40 x 70	CALOTTE ARGENTÉE/TOP SILVER MIRROR
131838	H53050	230	50	BA20D	50 x 80	CALOTTE ARGENTÉE/TOP SILVER MIRROR

C2/114

G8 POUR ECLAIRAGE OPERATOIRE TYPE HOSPILITE "DKK"
For operating room

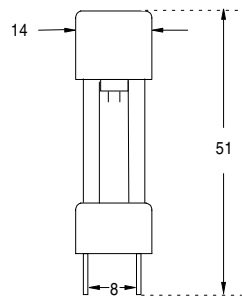
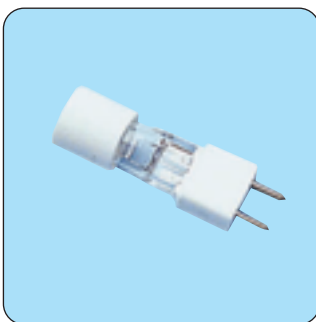

CODE STOCK PART NUMBER	RÉFÉRENCE	VOLTS	WATTS	TYPE
130773	H 24501	24	50	DKK

Des marques de tiers sont citées dans le présent catalogue lorsque leur référence est nécessaire pour informer ses clients de la destination de produits commercialisés par Orbitec. Ces marques restent la propriété des fabricants concernés.

SPECIALES ET TECHNIQUES
SPECIAL LAMPS

Click Below To Order

Interlight Specialty Bulbs
1-800-743-0005
www.interlight.biz

A AILETTE POUR BLOC OPERATOIRE "IODYNE" ET SUPPORT
room "ALM" type

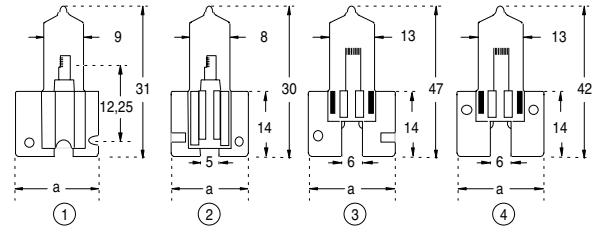
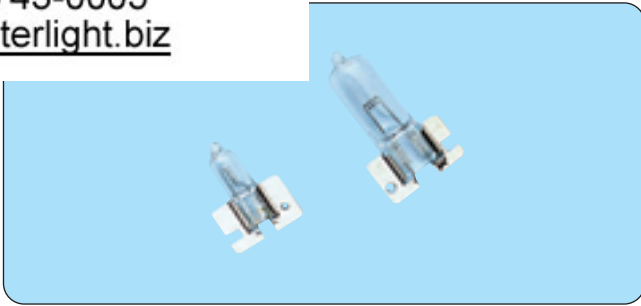

CODE STOCK PART NUMBER	RÉFÉRENCE	VOITS	WATTS	VERRE GLASS	DIMENSIONS D x L (MM)	FIGURE N° DRAWING N°	TYPE
130046	H 6936	12	36	CLAIR/CLEAR	21 x 30	1	A2114
131839	H 6970 CL	24	70	CLAIR/CLEAR	19,5 x 31	2	X511
131840	H 6970 DEP	24	70	DÉPOLI/FROSTED	19,5 x 31	2	X511
130042	H 247240	24	80	CLAIR/CLEAR	21 x 30	1	A2114
130041	H 6940 CL	24	100	CLAIR/CLEAR	19,5 x 31	2	X511
130047	H 6945	24	100	CLAIR/CLEAR	21 x 30	1	A2114
131841	H 6940 DEP	24	100	DÉPOLI/FROSTED	19,5 x 31	2	X511
131842	H 6947	24	100	CLAIR/CLEAR	26 x 47	3	A2614
130045	H 6950	24	120	CLAIR/CLEAR	26 x 47	3	A2614
130049	H 6952	24	120	CLAIR/CLEAR	26 x 47	3	ORIGINAL
130048	H 6951	23	100	CLAIR/CLEAR	26 x 47	3	ORIGINAL
131840	H 6970 DEP	24	70	DÉPOLI/FROSTED	26 x 42	3	A2614
131843	H 6990	24	140	CLAIR/CLEAR	26 x 42	4	A2614

SUPPORT DE LAMPE H 6950/Lamp holder for H 6950

131844	H 7146	POUR/FOR 1 LAMPE
131845	H 7147	POUR/FOR 2 LAMPES
131846	H 7148	POUR/FOR 3 LAMPES



Third parties trademarks are mentioned in this catalogue when reference thereto is necessary to inform customers about the intended use of products sold by Orbitec. These trademarks remain the property of the manufacturers concerned.

C2/116

LAMPES DENTAIRES TYPE "KAVO"

Dental lamps

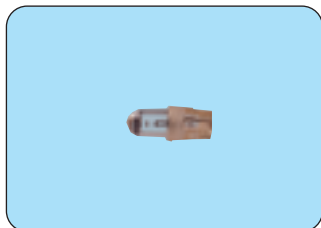

Click Below To Order

Interlight Specialty Bulbs
1-800-743-0005
www.interlight.biz

CODE STOCK PART NUMBER	RÉFÉRENCE	VOLTS	AMPÈRE/A	TYPE	FIGURE N° DRAWING N°
125275	M 815	3,2	0,7	45215	1
125276	M 814	3,2	0,7	45214	2
125279	M 813	3,2	0,7	45213	3
125277	M 811	3,2	-	45211	4
125278	M 812	3,2	-	45212	5

C2/117

LAMPES A REFLECTEUR DICHROIQUE

With dichroique mirror

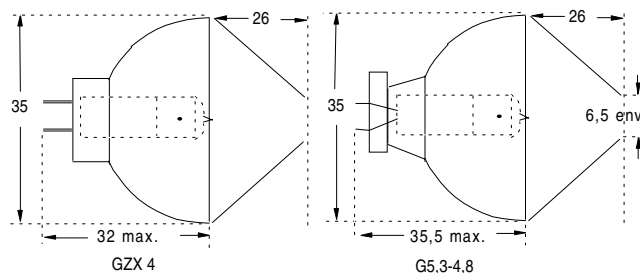

Lampes utilisées principalement dans le durcissement de matière synthétique, de colles, en endoscopie industrielle et médicale et fibres optiques. Ces lampes laissent passer les infrarouges et reflètent au maximum la lumière blanche (env. 400 à 750 nm).

These lamps are used in the following fields: hardening of glues and synthetic materials, in industrial medical and optic fiber endoscopies.

CODE STOCK PART NUMBER	RÉFÉRENCE	VOLTS	WATTS	CULOT BASE	DURÉE DE VIE AC LIFE
131471	THE 254	6	20	GU 4	
130379	H 164255	8	20	GZX 4	50
130258	H 164605	8	50	GZ 4	25
130260	H 164617	12	75	G 5,3-4,8*	25
130419	H 164613	12	75	G 5,3-4,8*	25
130566	H 64617 OS	12	75	G 5,3-4,8*	25
130262	H 164624	12	100	G 5,3-4,8*	25
131463	H 68035	14	35	GZ 4	50

* G 5,3-4,8 cosses plates / Flat Lugs.

Des marques de tiers sont citées dans le présent catalogue lorsque leur référence est nécessaire pour informer ses clients de la destination de produits commercialisés par Orbitec. Ces marques restent la propriété des fabricants concernés.

SPECIALES ET TECHNIQUES
SPECIAL LAMPS



C2/118

LAMPES INFRAROUGE A REFLECTEUR DICHROIQUE DORE
GZ6,35 infrared with gold dichroic reflector

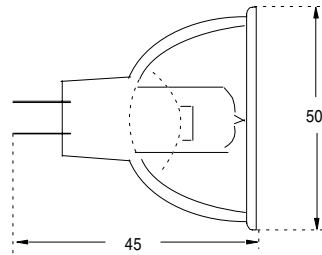

Lampe utilisée principalement pour souder, fondre ou chauffer les résines et autres matériaux synthétiques.

This lamp is used mainly to solder, melt or heat resins and other synthetic materials.

CODE STOCK PART NUMBER	RÉFÉRENCE	VOLTS	WATTS	CULOT BASE	DURÉE DE VIE AC LIFE
130950	H 164635	15	150	GZ6,35	50

Click Below To Order

Interlight Specialty Bulbs
1-800-743-0005
www.interlight.biz

C2/119

LAMPE POUR ECLAIRAGE OPERATOIRE DENTAIRE A CULOT METALLIQUE
For dental applications - Metal base

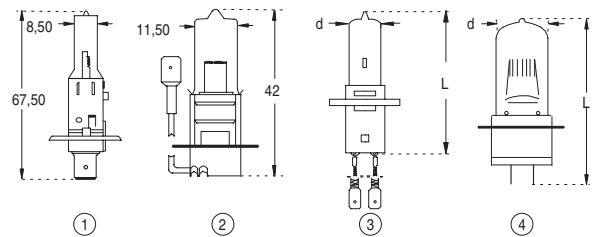
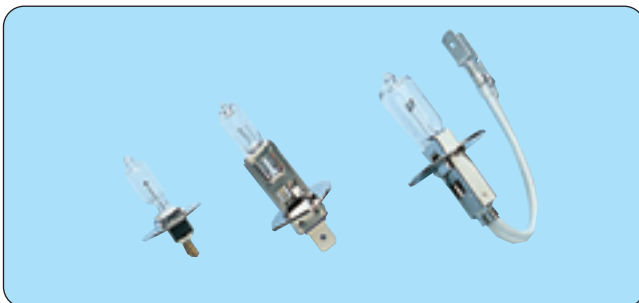

CODE STOCK PART NUMBER	RÉFÉRENCE	VOLTS/ AMPÈRE	WATTS	CULOT BASE	DIMENSIONS D x L (MM)	FIGURE N° DRAWING N°
122706	A 64150	12 V	55	P14,5S	8,5 x 67,5	1
122755	A 64151	12 V	55	PK22S	11,5 x 42	2
122758	H 192465	24 V	65	PK22S	11,5 x 42	2
130526	H 164317	6,6 A	45	PK30D	13,5 x 59	3
130528	H 164441	6,6 A	100	PK30D	13,5 x 59	3
130530	H 164382	6,6 A	200	PK30D	13,5 x 64	3
130154	H 164222	6 V	10	PG22	9 x 44	4
130156	H 164260	12 V	30	PG22	9 x 40	4
131184	H 164609	12 V	50	PG22	11,5 x 48	4
130242	H 164626	12 V	100	PG22	11,5 x 48	4

Third parties trademarks are mentioned in this catalogue when reference thereto is necessary to inform customers about the intended use of products sold by Orbitec. These trademarks remain the property of the manufacturers concerned.

SPECIALS ET TECHNIQUES
SPECIAL LAMPS



LAMPES POUR MICROPROJECTION, MICROFICHE, VISIONNEUSE ET MICROSCOPE
Projection, micro-films, microscopy

Click Below To Order

Interlight Specialty Bulbs
1-800-743-0005
www.interlight.biz

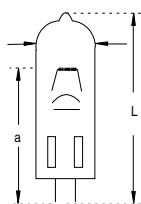

G4 : entraxe de 4 mm/pin Ø 1 mm
G6,35 : entraxe de 6,35 mm/pin Ø 1 mm
GY6,35 : entraxe de 6,35 mm

4 mm pin spacing
6,35 mm pin spacing
pin Ø 1,25 mm / 6,35 mm pin spacing

CODE STOCK PART NUMBER	RÉFÉRENCE	CODE ANSI	VOLTS	WATTS	TEMP. COUL. ° KELVIN	FLUX LUMENS	DIMENSIONS D x L (MM)	LCL A (MM)	DIM. FILAM. L x H (MM)	DURÉE DE VIE AC LIFE
G4										
130152	H 164223	M43	6	10	3 000	150	8,5 x 38	24	1,1 x 0,7	200
130153	H 64223 OS		6	10	3 000	150	8,5 x 38	24	1,1 x 0,7	200
130202	H 164225	ESA/EHD M29	6	10	3 200	205	9 x 31	19,5	1,6 x 0,6	100
130203	H 64225 PH	ESA/FHD	6	10	3 200	205	9 x 31	19,5	1,6 x 0,6	100
130103	H 64410	M42	6	10	2 700	120	9 x 31	19,5	3 x 0,5	2 000
130129	H 66605		6	10	2 700	120	9 x 30	19,5	3 x 0,5	2 000
130204	H 164250	ESB M30	6	20	3 200	475	9 x 31	19,5	2 x 1	100
130570	H 64250 PH	ESB.	6	20	3 200	475	9 x 30	19,5	2 x 1	100
130139	H 63910	BAR	6	20	-	350	10 x 33	-	CC6 BAR	1 000
130097	H 65761		6	30	3 200	760	9 x 31	19,5	1,5 x 1,5	100
130124	H 164258		12	20	3 000	350	9 x 33	19,5	3,5 x 0,8	2 000
130206	H 22035	M35	12	20	3 200	450	9 x 31	19,5	2,9 x 0,8	100
130007	H 22035 PH	M35	12	20	3 200	450	9 x 31	19,5	2,9 x 0,8	100
130099	H 164425 AX*		12	20	3 000	350	9 x 33	22	-	2 000
130273	H 64435		24	20			9 x 33			
130596	H 64435 PH		24	20			9 x 33			
130273	H 64435		24	20	3 000	350	9 x 33	22	-	2 000
G6,35										
132113	H 164440 AX		12	50		-				
130208	H 164610	BRL	12	50	3 300	1 600	11,5 x 44	30	3,3 x 1,6	50
130209	H 64610 OS		12	50	3 300	1 600	11,5 x 44	30	3,3 x 1,6	50
130214	H 164633	BRJ A1/234	15	150	3 400	5 000	11,5 x 44	30	4,8 x 3,0	50
130215	H 64633 OS	EVB/BRJ	15	150	3 400	5 000	11,5 x 44	30	4,8 x 3,0	50
130748	H 122850 AX*		22,8	50	-	1 000	13 x 44	30	2 x 5	1 000
130747	H 122840		22,8	40	-		11 x 42			
130749	H 122850		22,8	50	-		11 x 42			
130358	H 21110		24	55	3 000	1 200	11 x 44	30	6,7 x 3,0	750
130191	H 164638		24	100	3 400	2 900	13,5 x 50	30	5,3 x 2,6	300
131822	H 65905*		24	120	3 400	3 500	11 x 44	33	-	50
130218	H 164642	FDU	24	150						
130216	H 164640	FCS	24	150	3 400	6 000	13,5 x 50	32	5,3 x 2,9	50
130217	H 64640 OS	FCS	24	150	3 400	6 000	13,5 x 50	32	5,3 x 2,9	50
130223	H 164655	EHJ A1/223	24	250	3 400	9 400	13,5 x 55	33	7,0 x 3,5	50
130220	H 164655 GE	EHJ	24	250	3 400	9 400	13,5 x 57	33	7,0 x 3,5	50
130222	H 164657	EVC/M33/FGX	24	250	3 200	8 400	13,5 x 55	33	7,0 x 3,5	300

* Filament axial/Axial Filament.

Des marques de tiers sont citées dans le présent catalogue lorsque leur référence est nécessaire pour informer ses clients de la destination de produits commercialisés par Orbitec. Ces marques restent la propriété des fabricants concernés.

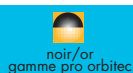

CODE STOCK PART NUMBER	RÉFÉRENCE	CODE ANSI	VOLTS	WATTS	TEMP. COUL. ° KELVIN	FLUX LUMENS	DIMENSIONS D x L (MM)	LCL A (MM)	DIM. FILAM. L x H (MM)	DURÉE DE VIE AC LIFE
130236	H 64657 OS		24	250	3 200	8 400	13,5 x 55	33	7,0 x 3,5	300
131929	H 164657 DEP (1)		24	250	3 200	-	13,5 x 55	33	7,0 x 3,5	300

GY6,35

130113	H 64440 OS		12	50	3 000	950	12 x 44	30	5,2 x 1,6	2 000
132113	H 164440 AX*		12	50	3 000	950	12 x 44	30	-	2 000
130213	H 164625	FCR A1/215	12	100	3 400	3 400	11,5 x 44	30	4,2 x 2,3	50
130211	H 64625 OS	FCR	12	100	3 400	3 400	11,5 x 44	30	4,2 x 2,3	50
130090	H 64623	EVA M28	12	100	3 200	2 800	11,5 x 44	30	4,7 x 2,7	2 000
130680	H 64623 PH	EVA/M28	12	100	3 200	2 800	11,5 x 44	30	4,7 x 2,7	2 000

GZ6,35

132134	H62138		12	100			11 x 39			50
--------	---------------	--	----	-----	--	--	---------	--	--	----

* Filament axial / Axial filament.
(i) Version satinée / Frosted type.

Click Below To Order

Interlight Specialty Bulbs
1-800-743-0005
www.interlight.biz

C2/121

E10 - MINILOUPE - Ø 9,5 x 24 MM

Lens lamp

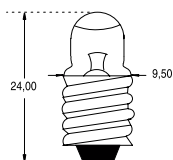

CODE STOCK PART NUMBER	RÉFÉRENCE	VOLTS	mA	WATTS	FLUX LUMENS	DURÉE DE VIE AC LIFE
111260	E 3649	1,2	220	0,26	0,8	10
111265	E 3647	2,2	180	0,39	2,9	10
111270	E 3651	2,2	250	0,55	4,3	10
111273	E 3622	2,2	300	0,66	5,1	10
111376	E 3656	2,2	400	0,88	7,4	10
111275	E 3643	2,5	200	0,5	4,3	10
111277	E 3648	2,5	300	0,75	6,5	10
111378	E 3663	3,3	300	1,00	9,3	10
111290	E 3644	3,7	300	1,11	10,7	10

Third parties trademarks are mentioned in this catalogue when reference thereto is necessary to inform customers about the intended use of products sold by Orbitec. These trademarks remain the property of the manufacturers concerned.

C2/122

E10/BA9S SPHERIQUE MINIATURE
Round miniature bulb

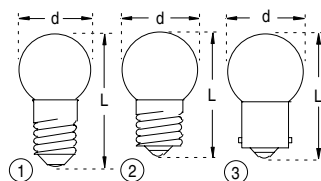

Click Below To Order

Interlight Specialty Bulbs
1-800-743-0005
www.interlight.biz

CODE STOCK PART NUMBER	RÉFÉRENCE	VOLTS	WATTS/ AMPÈRE	CULOT BASE	DIMENSIONS D x L (MM)	FIGURE N° DRAWING N°
116930	B 6251	6	5 W	BA9S	15 x 28	3
018980	OR 9069	6	6 W	BA9S	15 x 28	3
125537	LT 1503	6	12 W	BA9S	10 x 26	3
125501	LT 2109	6	15 W	BA9S	15 x 28	3
125543	LT 5203 Z*	12	10 W	BA9S	15 x 28	3
122220	A 15001	6	10 W	BA15S	18 x 37	3
125531	LT 14	2,47	0,3 A	E10	9 x 23	1
125532	LT 157	5,8	1,10 A	E10	18 x 30	2
018920	OR 9071	6	4 W	E10	15 x 27	2
125614	LT 5021	6	5 W	E10	16 x 35	2
018970	OR 9059	6	6 W	E10	15 x 28	2
125625	LT 8 G 102	6	10 W	E10	15 x 30	2
125503	LT 2111	6	15 W	E10	15 x 28	2

* Filament plat.

* Flat filament.

C2/123

E12 DEPOLIE (BLK) POUR MICROSCOPE TYPE "BAUSCH ET LOMB"
Frosted bulb for microscope



CODE STOCK PART NUMBER	RÉFÉRENCE	VOLTS	WATTS	DIMENSIONS D x L (MM)
125578	LT 31307	130	30	34 x 56

C2/124

E12 POUR MICROSCOPE
For microscope

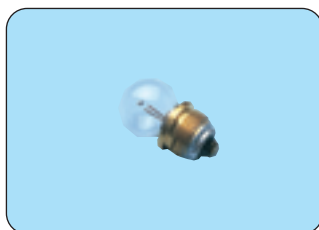

CODE STOCK PART NUMBER	RÉFÉRENCE	VOLTS	WATTS	DIMENSIONS D x L (MM)	PAS MÉTRIQUE	DURÉE DE VIE AC LIFE
125220	M 409	6	6	14 x 28	M 12	500

Des marques de tiers sont citées dans le présent catalogue lorsque leur référence est nécessaire pour informer ses clients de la destination de produits commercialisés par Orbitec. Ces marques restent la propriété des fabricants concernés.



C2/125

E19 POUR MICROSCOPE TYPE "REICHART"
For microscope



Click Below To Order

Interlight Specialty Bulbs
1-800-743-0005
www.interlight.biz

CODE STOCK PART NUMBER	RÉFÉRENCE	VOLTS	WATTS	DIMENSIONS D x L (MM)
125516	LT 91569	6	30	34 x 62

C2/126

B15S/B15D A FILAMENT PONCTUEL
With punctual filament

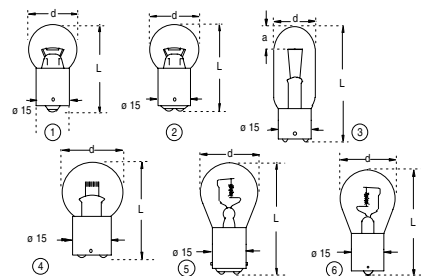

Lampes utilisées principalement en microscopie / Mainly used for microscopes.

CODE STOCK PART NUMBER	RÉFÉRENCE	CODE ANSI	VOLTS	WATTS/ AMPÈRE	CULOT BASE	DIMENSIONS D x L (MM)	FIGURE N° DRAWING N°
125514	LT 1434		3,7	2,75 A	BA15S	16 x 44	6
125528	LT 2106		3-6	2 A	B15S	23 x 35	1
112661	P 8013		6	10 W	B15D	25 x 43	4
125591	LT 2128		6	15 W	B15D	18 x 36	2
112701	P 8017*		6	15 W	B15D	19 x 54	3
112703	P 8018*		6	15 W	B15D	19 x 53	3
125538	LT 2145**		6	15 W	B15D	19 x 35	3
125592	LT 2114		6	18 W	B15D	18 x 36	2
125504	LT 2113		6	18 W	B15D	19 x 52	3
125521	LT 2118		6	30 W	B15D	25 x 56	3
125507	LT 2121		6	33 W	B15D	25 x 77	3
125506	LT 2120		6	33 W	B15D	25 x 46	5
125535	LT 812		6,5	1,7 A	B15D	23 x 40	2
125522	LT 1493		6,5	2,75 A	B15D	25 x 48	4
125515	LT 2202		7	35 W	B15D	25 x 50	3
125630	LT 2306		9	2 A	B15S	18 x 35	6
125527	LT 2167		12	15 W	B15D	19 x 35	3
122415	A 7582**		12	25 W	B15S	26 x 48	6
125508	LT 9118		12	30 W	B15D	25 x 56	3
130274	H 63100	EJY	19	80 W	GX5,3	50 x 45	
130275	H 63113	EJA	21	150 W	GX5,3	50 x 45	
125566	LT 31317		130	30 W	B15D	45 x 67	4

* P8017 : a = 7 mm durée de vie/Life 1 000 hours.

* P8018 : a = 5 mm

** Filament axial/Axial Filament.

Third parties trademarks are mentioned in this catalogue when reference thereto is necessary to inform customers about the intended use of products sold by Orbitec. These trademarks remain the property of the manufacturers concerned.

SPECIALLES ET TECHNIQUES
SPECIAL LAMPS

A3/127

B15S/B15D A CALOTTE ARGENTEE LATERALE POUR MICROSCOPE

With side silver mirror for microscope

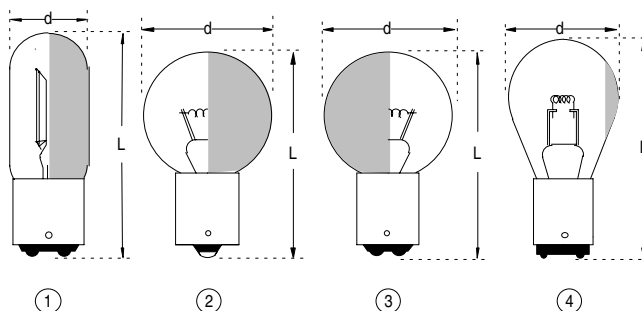

CODE STOCK PART NUMBER	RÉFÉRENCE	VOLTS	WATTS	CULOT BASE	DIMENSIONS D x L (MM)	DURÉE DE VIE AC LIFE	FIGURE N° DRAWING N°
130763	H 036031	12	40	B15S	30 x 48	200	2
125555	LT 3915	110	20	BA15D	30 x 48	300	3
125556	LT 3562	110	20	BA15D	25 x 65	300	1
125544	LT 3609	120	30	B15D	35 x 60	200	4
125557	LT 3604	110	20	BA15D	35 x 59	200	4
125546	LT 3601	220	20	B15D	30 x 48	300	3
125548	LT 3610	220	20	B15D	25 x 65	300	1
125517	LT 3602	220	30	B15D	25 x 55	300	1
125550	LT 3603	220	30	B15D	35 x 60	200	4

Click Below To Order

Interlight Specialty Bulbs
1-800-743-0005
www.interlight.biz

DECOUVREZ NOTRE GAMME DE DOUILLES, BALLASTS,
TRANSFORMATEURS ET ACCESSOIRES
DANS NOTRE NOUVEAU CATALOGUE
ECLAIRAGE ARCHITECTURAL
ET COMPOSANTS POUR
LUMINAIRES

A WIDE RANGE OF LAMPHOLDERS, BALLASTS,
TRANSFORMERS AND ACCESSORIES
IS NOW AVAILABLE IN OUR
ARCHITECTURAL LIGHTING
AND COMPONENTS' CATALOGUE

Des marques de tiers sont citées dans le présent catalogue lorsque leur référence est nécessaire pour informer ses clients de la destination de produits commercialisés par Orbitec. Ces marques restent la propriété des fabricants concernés.

SPECIALES ET TECHNIQUES
SPECIAL LAMPS



Click Below To Order

C2/128

LAMPES A FILAMENT PONCTUEL CULOTS DIVERS

With punctual filament

Interlight Specialty Bulbs
1-800-743-0005
www.interlight.biz

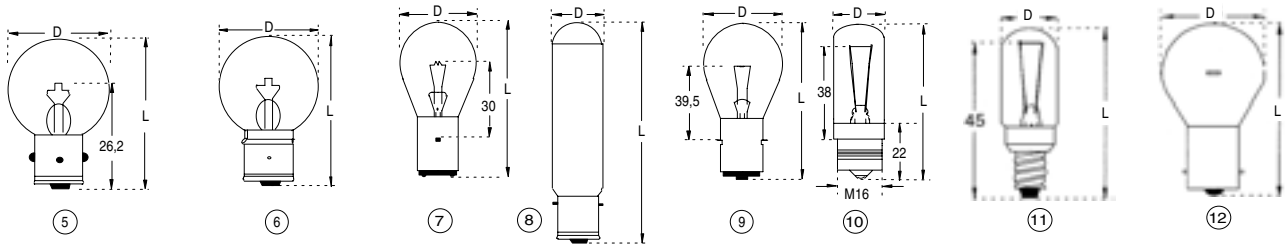
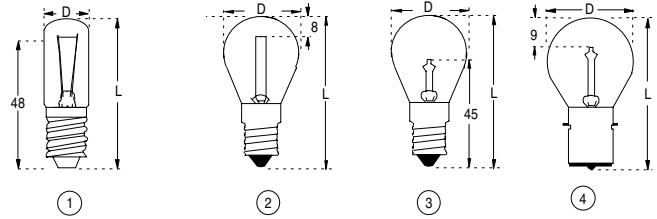

CODE STOCK PART NUMBER	RÉFÉRENCE	VOLTS	WATT AMPÈRE	CULOT BASE	DIMENSIONS D x L (MM)	TYPE	FIGURE N° DRAWING N°
125530	LT 77910	6	15 W	SPECIAL	24 x 34	NIKON	-
112704	P 7768	6	15 W	E14	19 x 59		1
112770	P 7242	6	15 W	SPECIAL M16	19 x 54		10
112610	P 18023	6	15 W	E10	18 x 52		11
112710	P 8001	6	4,35 A	E14	35 x 64		2
112718	P 8100	6	5 A	E14	35 x 65		3
112712	P 8025	6	5 A	BA20D	35 x 60		4
112726	P 6716	6	5 A	BA21S	40 x 61		5
125597	LT 71818	10	70 W	P28S	50 x 78		6
112758	P 8024	12	40 W	BA20D	35 x 64		7
112760	P 8022	12	50 W	BA20D	35 x 63		9
125584	LT 348	12	60 W	BA20D	35 x 69		9
112756	P 7029	12	5 A	BA21S	40 x 62		5
130467	H 88100	12	100 W	P28S	28 x 135		8
125509	LT 2503	12	100 W	P28S	50 x 84		6
125511	LT 2505	12	150 W	P28S	60 x 96		6
112764	P 8029	15	60 W	BA20D	35 x 63		7
112900	P 6144 F	16	8 A	BA21D	40 x 63		12

Third parties trademarks are mentioned in this catalogue when reference thereto is necessary to inform customers about the intended use of products sold by Orbitec. These trademarks remain the property of the manufacturers concerned.

C2/129

P30S - P30D - P44S ET SPECIAL
With special ring

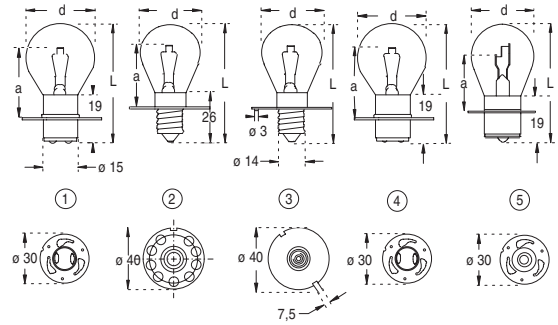

Lampes utilisées principalement en microscopie et ophtalmologie/For microscopy and ophtalmology.

CODE STOCK PART NUMBER	RÉFÉRENCE	VOLTS	WATTS/ AMPÈRE	CULOT BASE	DIMENSIONS D x L (MM)	LCL A (MM)	TYPE	FIGURE N° DRAWING N°
112706	P 7931	6	15 W	P30S	18 x 54	35		
125512	LT 1520	6	15 W	P30D	25 x 48	31		1
125491	OR 1300	6	15 W	-	-	-	LS15 OLYMPUS	
125493	OR 1168	6	15 W	-	-	-	GAMBS	
125513	LT 1468 X	6	4,5 A	P30D	25 x 48	31		1
125490	OR 1900*	6	4,5 A	P44S	33 x 63	33	HAAG. STREIT 900-930	2
125495	OR 1940*	6	4,5 A	P40S	33 x 63	33	HAAG. STREIT 940-750	3
125492	OR 1330	6	30 W	-	-	-	LS30 OLYMPUS	
125524	LT 1649	6,5	2,75 A	P30D	25 x 48	31		1
125526	LT 1460	6,5	2,75 A	P30D	25 x 48	31		1
125570	LT 1460 X*	6,5	2,75 A	P30D	25 x 48	31		1
125572	LT 1630 X	6,25	2,75 A	P30D	25 x 48	25		4
125576	LT 1631 X	6,25	2,75 A	P30D	25 x 48	31		1
122416	A 7582 X	12	25 W	P30S	25 x 48	25		5
125564	LT 1634	20	1 A	P30D	25 x 48	31		1

* Contact en argent/Silver contact.

Click Below To Order

C2/130

POUR MICROSCOPE TYPE "LEITZ ET WILD"
For microscope

Interlight Specialty Bulbs
1-800-743-0005
www.interlight.biz

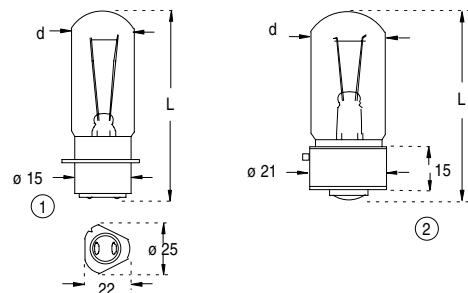

CODE STOCK PART NUMBER	RÉFÉRENCE	VOLTS	WATTS	DIMENSIONS D x L (MM)	DURÉE DE VIE AC LIFE	CULOT BASE	FIGURE DRAWING N°	TYPE
125529	LT 177 L	6	15	18 x 52	80	SPECIAL	1	LEITZ
125530	LT 77910	6	15	24 x 34		SPECIAL		NIKON
125505	LT 70249	6	20	18 x 52	80	SPECIAL	2	WILD
125536	LT 2480	6	33	25 x 50	100	BA15S + COLLERETTE	2	

Des marques de tiers sont citées dans le présent catalogue lorsque leur référence est nécessaire pour informer ses clients de la destination de produits commercialisés par Orbitec. Ces marques restent la propriété des fabricants concernés.

SPECIALES ET TECHNIQUES
SPECIAL LAMPS

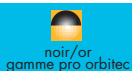

Click Below To Order

LAMPES POUR MICROSCOPE ET MICROPROJECTION
FOR MICROSCOPY AND MICROPROJECTION

Interlight Specialty Bulbs
1-800-743-0005
www.interlight.biz

SCOPE TYPE "RODENSTOCK"

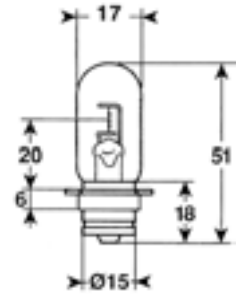
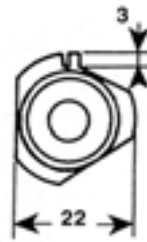

CODE STOCK PART NUMBER	RÉFÉRENCE	VOLTS	WATTS	DIMENSIONS D x L (MM)	TYPE
125545	LT 70506	6	15	18 x 51	GÉNÉRIQUE
125547	LT 70464	12	25	18 x 51	GÉNÉRIQUE
125558	RD 70506	6	15	18 x 51	ORIGINAL 70506
125559	RD 70464	12	25	18 x 51	ORIGINAL 70464

C2/132 **POUR MICROSCOPE TYPE "ZEISS"**
For microscope

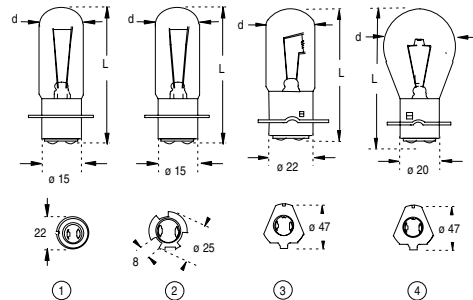

CODE STOCK PART NUMBER	RÉFÉRENCE	VOLTS	WATTS	DIMENSIONS D x L (MM)	DURÉE DE VIE AC LIFE	FIGURE N° DRAWING N°
125520	LT 76 Z	6	15	18 x 52	80	1
125519	LT 77 Z	6	15	18 x 52	80	2
125542	LT 29 Z	6	15	28 x 49	-	2
125539	LT 93 Z	12	35	35 x 62	-	4
125518	LT 53 Z	6	25	25 x 69	80	3
125500	LT 58 Z	6	30	35 x 62	80	4
125510	LT 86 Z	6	50	35 x 62	80	4

C2/133 **POUR MESUROSCOPE TYPE "ZEISS"**
For mesuroscope

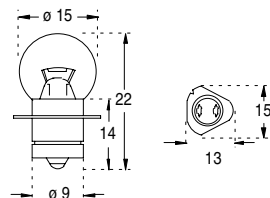

CODE STOCK PART NUMBER	RÉFÉRENCE	VOLTS	WATTS	DIMENSIONS D x L (MM)
125502	LT 300799	6	5	15 x 22

Third parties trademarks are mentioned in this catalogue when reference thereto is necessary to inform customers about the intended use of products sold by Orbitec. These trademarks remain the property of the manufacturers concerned.

SPECIAL LAMPS

Interlight Specialty Bulbs
1-800-743-0005
www.interlight.biz

TYPE "NARVA"

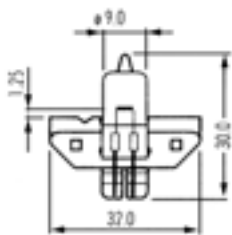
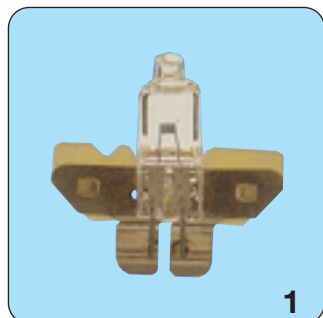

1

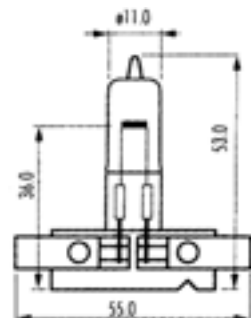
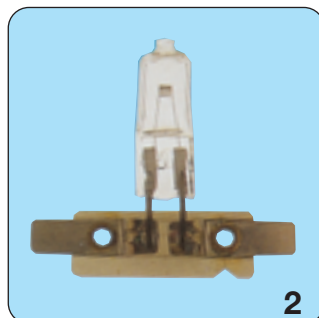

2

Autres lampes sur demande avec un culot pre-focus

Other lamps with pre-focus base available on request

CODE STOCK PART NUMBER	REFERENCE	VOLTS	WATTS	CULOT BASE	TYPE	FIGURE N° DRAWING N°
125541	LT 6010	6	10	PY16 - 1,25	55122/HLWS5	1
125498	LT 6020	6	20	PY16 - 1,25	55133/HLWS5	1
125499	LT 6025	6	25	PY16 - 1,25	55147/HLWS5-A	1
125551	LT 55204	12	50	PY24 - 1,5	55204/HLWS5	2
125552	LT 55305	12	100	PY24 - 1,5	55305/HLWS5	2
125540	LT 12100	12	100	PY24 - 1,5	55307/HLWS5-A	2



POUR MICROSCOPE TYPE "NARVA"
For microscope

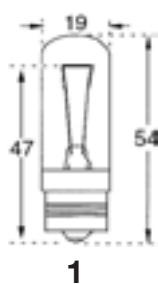

1

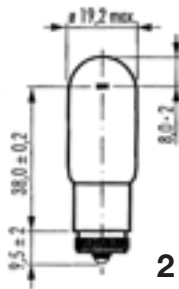

2

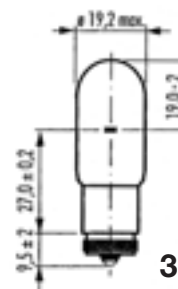

3

CODE STOCK PART NUMBER	REFERENCE	VOLTS	WATTS	CULOT BASE	TYPE	FIGURE N° DRAWING N°
125343	P 7241	6	15	Z16	67241	1
112770	P 7242	6	15	Z16	67242	1
125344	P 7273	6	15	Z16	67273	2
125345	P 7471	6	30	Z16	67471	3

Autres lampes sur demande culot Z16 (M16)

Des marques de tiers sont citées dans le présent catalogue lorsque leur référence est nécessaire pour informer ses clients de la destination de produits commercialisés par Orbitec. Ces marques restent la propriété des fabricants concernés.

C2/136

G4 TYPE AMERICAIN
Ø 7 x 25 mm - US type

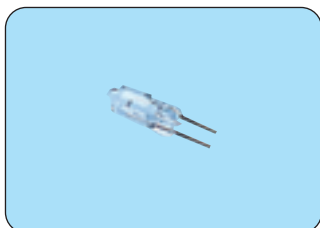

Click Below To Order

Interlight Specialty Bulbs
1-800-743-0005
www.interlight.biz

CODE STOCK PART NUMBER	RÉFÉRENCE	VOLTS	AMPÈRE A	WATTS
125523	LT 787	6	1,67	10
125574	LT 778	6	3,30	20
125549	LT 774	12	-	8
125554	LT 783	12	-	12

C2/137

LAMPE SPECIALE TYPE "HITACHI" ET "WILD"

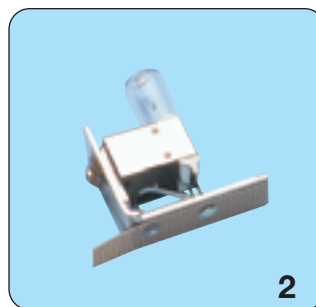
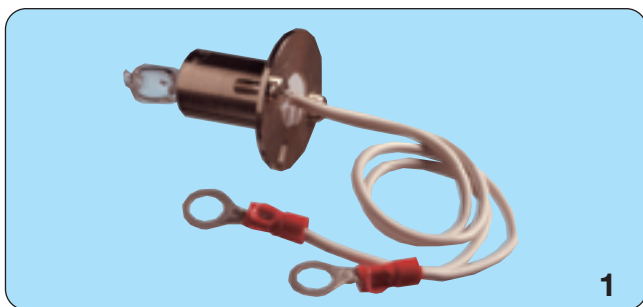

CODE STOCK PART NUMBER	RÉFÉRENCE	VOLTS	WATTS	CULOT BASE	TYPE	DURÉE DE VIE AC LIFE	PHOTO N°
131923	OR 1390	12	20	P15	HITACHI 705-0840		1
131924	OR 1393	12	50	SPÉCIAL	WILD 384643	50	2

Third parties trademarks are mentioned in this catalogue when reference thereto is necessary to inform customers about the intended use of products sold by Orbitec. These trademarks remain the property of the manufacturers concerned.

C2/138

GX5,3/GZ6,35 A MIROIR DICHROÏQUE
With dichroic mirror

Click Below To Order

Interlight Specialty Bulbs
1-800-743-0005
www.interlight.biz

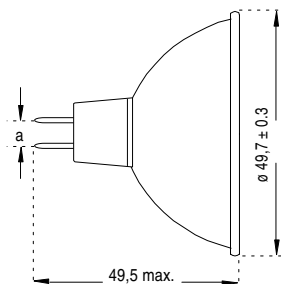
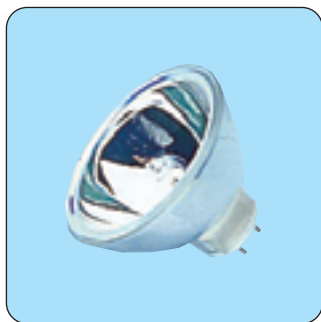

GX5,3 : entraxe des pins de 5,3 mm / 5,3 mm pin spacing

GZ6,35 : entraxe des pins de 6,35 mm / 6,35 mm pin spacing

CODE STOCK PART NUMBER	RÉFÉRENCE	CODE ANSI	VOLTS	WATTS	TEMP. COUL. ° KELVIN	DISTANCE DE MONTAGE (MM)	DURÉE VIE AC LIFE
---------------------------	-----------	--------------	-------	-------	-------------------------	-----------------------------	----------------------

GX5,3

130300	H 63180	EPT	10,8	42	2 900	-	8 000
130343	H 41860 WFL	BAB	12	20	3 100	40	2 000
132010	H 41870 MFL	ENL	12	50	3 100	50	2 000
131210	H 63159	DDL	20	150	3 150	200	500
131216	H 63165	DDS	21	80	3 125		1 000
130275	H 63113	EJA	21	150	3 350	28	40
130282	H 64653	ELC	24	250	3 400	30	50
130406	H 63196	ENX	82	360	3 300	300	75

GZ6,35

130264	H 164607	EFM	8	50	3 300	32	50
130266	H 164615	EFN	12	75	3 350	32	50
130269	H 164627	EFP	12	100	3 350	32	50
130259	H 161479	-	12	100	-	32	1 500
130270	H 164634	EFR	15	150	3 350	32	50

C2/139

GX7,9 - MR 18 - A MIROIR
Ø 58 mm - With mirror

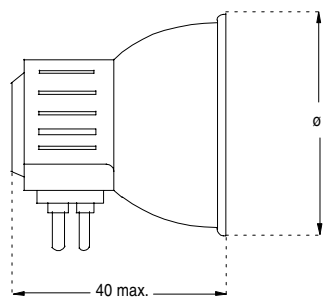

CODE STOCK PART NUMBER	RÉFÉRENCE	CODE ANSI	VOLTS	WATTS	TEMP. COUL. ° KELVIN	DISTANCE DE MONTAGE (MM)	DURÉE VIE AC LIFE
130292	H 63154	DNF A1/226	21	150	3 400	70	25
130679	H 63155	ELZ	21	150	3 400	70	60
130294	H 63160	EMM/EKS	24	250	3 400	66	50
130298	H 63166	DNE	120	150	3 350	70	15

Des marques de tiers sont citées dans le présent catalogue lorsque leur référence est nécessaire pour informer ses clients de la destination de produits commercialisés par Orbitec. Ces marques restent la propriété des fabricants concernés.

C2/140

TYPE "HBO" LAMPE A DECHARGE AUX VAPEURS DE MERCURE

Discharge mercury vapor lamp

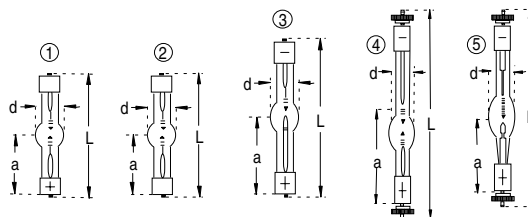
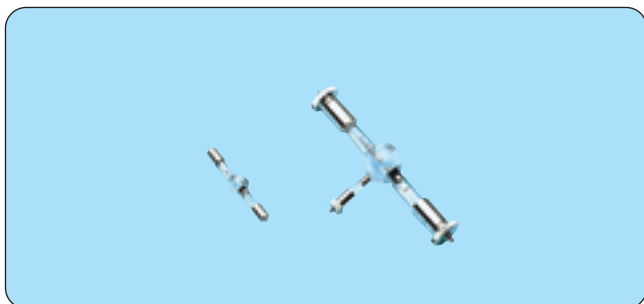

Lampes utilisées principalement en microscopie, endoscopie à fluorescence et fibre optique

Use mainly in microscopy and fluorescent or optic fiber endoscopy

CODE STOCK PART NUMBER	RÉFÉRENCE	VOLTS	AMPÈRE	WATTS	FLUX LUMINEUX	DIAMÈTRE (MM)	LONGUEUR (MM)	DISTANCE (MM)	DURÉE DE VIE AC LIFE	FIGURE N° DRAWING N°
130776	H 50 W/3	22VDC	2,3	50	1 300	9,5	53	22	200	1
130774	H 50 W/ACL1	39/45 VAC	1,3	50	2 000	9,5	53	22	100	2
130775	H 50 W/ACL2	34/39 VAC	1,45	50	2 000	9,5	53	22	100	2
130780	H 100 W/2	20 VDC	5	100	2 500	10	90	43	200	3
130793	H 103 W/2	23 VDC	4,3	100	3 000	10	90	43	300	3
130782	H 200 W/2L1	61/53AC/DC	3,6	200	10 000	17	125	40	200	4
130787	H 200 W/2L2	61/53AC/DC	4,2	200	10 000	17	125	40	200	4
130790	H 200 W/DC	57 VDC	3,5	200	10 000	17	125	40	1000	4
130784	H 200 W/4	61 VDC	3,6	200	9 500	17	125	40	200	4
130800	H 200 W*	61/53AC/DC	3,6/4,2	200	9 500	18	108	40	200	5
130786	H 350 W	60 VDC	6	350	-	20	127	52,5	600	4
130779	H 350 W/S	68 VDC	5,15	350	-	20	127	52,5	600	4

* H 200 W 3 électrodes - ancien modèle / With 3 electrodes old version.

Click Below To Order

Interlight Specialty Bulbs
1-800-743-0005
www.interlight.biz

**DECOUVREZ NOTRE GAMME DE DOUILLES,
TRANSFORMATEURS ET ACCESSOIRES
DANS NOTRE NOUVEAU CATALOGUE
D'ÉCLAIRAGE ARCHITECTURAL
ET COMPOSANTS POUR
LUMINAIRES**

**A WIDE RANGE OF LAMP HOLDERS, BALLASTS,
TRANSFORMERS AND ACCESSORIES
IS NOW AVAILABLE IN OUR
ARCHITECTURAL LIGHTING
AND COMPONENTS' CATALOGUE**

Third parties trademarks are mentioned in this catalogue when reference thereto is necessary to inform customers about the intended use of products sold by Orbitec. These trademarks remain the property of the manufacturers concerned.

C2/141

TYPE "XBO" LAMPE A DECHARGE XENON HAUTE PRESSION

High pressure Xenon discharge lamps "XBO" type

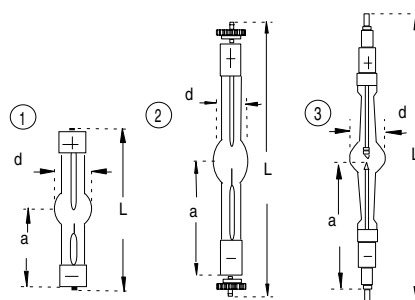
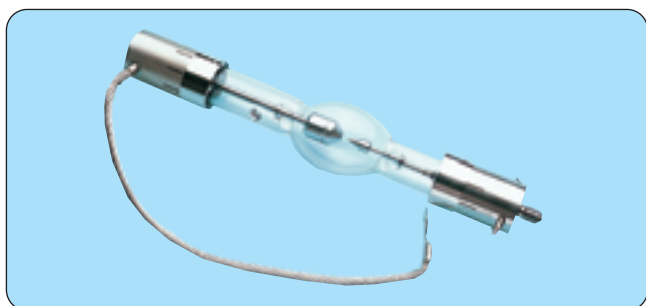

Pour microscope LEICA - LEITZ - ZEISS - NIKON / For LEICA / LEITZ / ZEISS and NIKON branded microscopes.

CODE STOCK PART NUMBER	RÉFÉRENCE	VOLTS	AMPÈRES	WATTS	FLUX LUMENS	DIMENSIONS D x L (MM)	DISTANCE A (MM)	DURÉE DE VIE AC LIFE	FIGURE N° DRAWING N°
130816	X 75 W/2	14	5,4	75	1 000	10 x 90	43	400	1
130825	X 100 W/OFR	15	6,7	100	1 800	11 x 90	44,5	500	1
130818	X 150 W/1	20	7,5	150	3 000	20 x 150	57	1 200	2
130827	X 150 W/1 OFR	20	7,5	150	3 000	20 x 150	57	1 200	2
130824	X 450 W/OFR	18	25	450	13 000	29 x 260	95,5	2 000	3

Click Below To Order

Interlight Specialty Bulbs
1-800-743-0005
www.interlight.biz

C2/142

LAMPES FLUO CIRCULAIRE A 4 PINS

4 Pins fluo circular shape

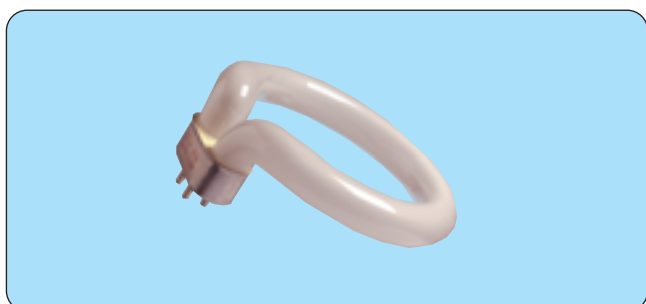

Lampe fluo sortie 4 pins (droit ou coudé)

CODE STOCK PART NUMBER	RÉFÉRENCE	VOLTS	MA	WATTS	COULEUR COLOR	TEMP. COUL. ° KELVIN	DIMENSIONS L x L (MM)	TYPE
007880	FL 8030	52	160	8	BLANC CHAUD/WARM WHITE	3 500	80 x 80	COUDÉ/BENT
007879	FL 8035	52	160	8	BLANC CHAUD/WARM WHITE	3 500	80 x 80	DROIT/STRAIGHT
007871	FL 9230	52	210	10	BLANC CHAUD/WARM WHITE	3 500	92 x 92	DROIT/STRAIGHT

Des marques de tiers sont citées dans le présent catalogue lorsque leur référence est nécessaire pour informer ses clients de la destination de produits commercialisés par Orbitec. Ces marques restent la propriété des fabricants concernés.

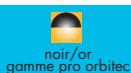

Interlight Specialty Bulbs
1-800-743-0005
www.interlight.biz

E "GEMINI/MARC" A REFLECTEUR DICHROIQUE

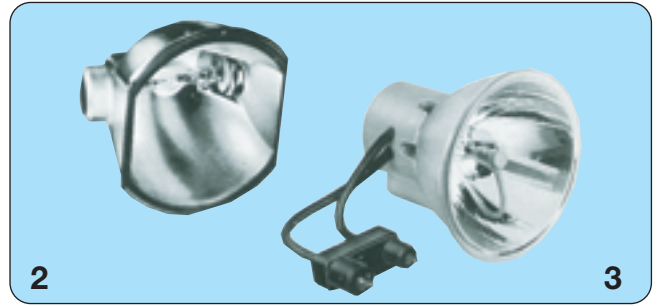
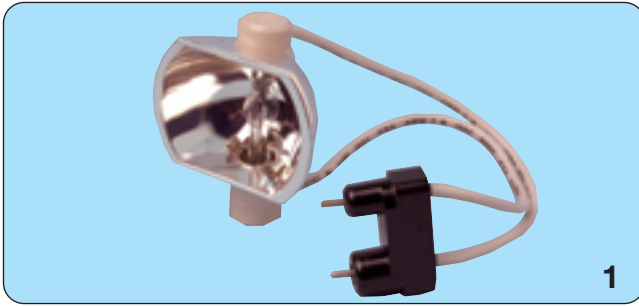

Lampes utilisées principalement pour les projecteurs de films 16 mm, les spots de poursuite et dans le domaine Médical (éclairage de salle d'opération...).

These lamps are used in the 16 mm film projectors', in tracking spots, and in the medical field (operating room lighting...).

CODE STOCK PART NUMBER	RÉFÉRENCE	CODE ANSI	VOLTS	WATTS	TEMP. COUL. °KELVIN	DISTANCE DE MONTAGE (MM)	DURÉE DE VIE AC LIFE	PHOTO N°
008505	GEMINI 300	EZG	35	300	6 000	37	75	1
008511	MARC 300	EZM	37,5	300	5 500	52	25	2
008577	MARC 350/16T	EZT	45	350	5 000	52	50	3

C2/144

TYPE "HTI" A DECHARGE A VAPEURS METALLIQUES

For endoscopy - Metal halide type

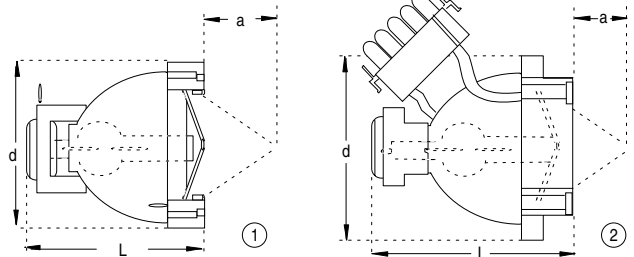

-Les lampes fonctionnent avec des appareils d'alimentation à courant angulaire
Douille pour HTI sur demande
Explication des références
FS : spécial fibres optiques
C : avec câble et connecteurs
Lampes avec miroir dichroïc, réamorçage à chaud possible

*Operate with angular current ballast
Socket for HTI upon request
Key to abbreviations:
FS = For optic fiber
C = With cables
Dichroic mirror*

CODE STOCK PART NUMBER	RÉFÉRENCE	VOLTS	AMPÈRE	WATTS	TEMP. COUL. °KELVIN	DIMENSIONS D x L (MM)	DISTANCE A (MM)	DURÉE DE VIE AC LIFE	CULOT BASE	FIGURE N° DRAWING N°
008487	HTI 250/22FS	45	6	270	5 600	67 x 73	22	250	-	1
008477	HTI 250/32C	45	6	270	5 600	67 x 73	32	250	CABLÉ	2
008479	HTI 250/32	45	6	270	5 600	67 x 73	32	250	-	1
008478	HTI 400/24	55	7,3	400	5 600	24 x 73	24	250	CABLÉ	2
008523	HTI 403/24	55	7,3	400	5 600	24 x 73	24	500	CABLÉ	2

Third parties trademarks are mentioned in this catalogue when reference thereto is necessary to inform customers about the intended use of products sold by Orbitec. These trademarks remain the property of the manufacturers concerned.

C2/145

TYPE "STRYKER" POUR ENDOSCOPIE
For endoscope

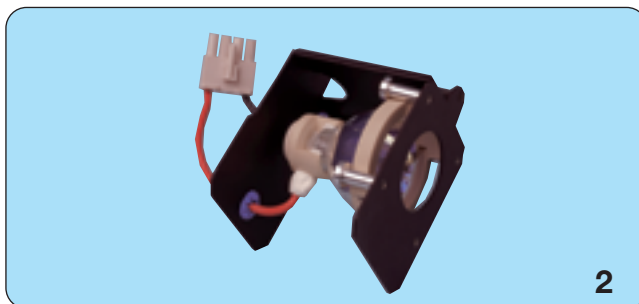
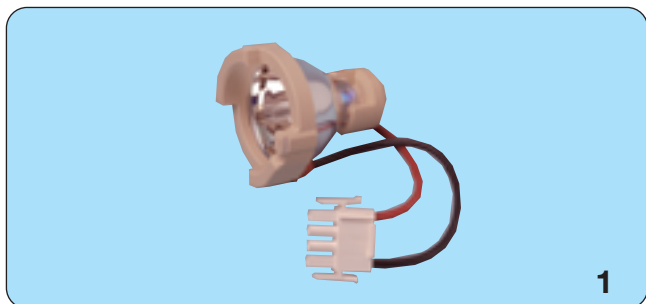

Lampe « STRYKER » 5000 livrée et montée sur son support / Type "Stryker 5000" is pre-mounted with holder

CODE STOCK PART NUMBER	RÉFÉRENCE	VOLTS	WATTS	CULOT BASE	RÉFÉRENCE	PHOTO N°
008488	HTI 250/32 ST	45	270	CABLE	STRYKER 3000	1
008491	HTI 250/22 ST4	45	270	CABLE	STRYKER 4000	1
130863	HTI 250/22 ST5	45	270	CABLE + SUPPORT (HOLDER)	STRYKER 5000	2

Click Below To Order

Interlight Specialty Bulbs
1-800-743-0005
www.interlight.biz

C2/146

TYPE "DYONICS" POUR ENDOSCOPIE
For endoscope

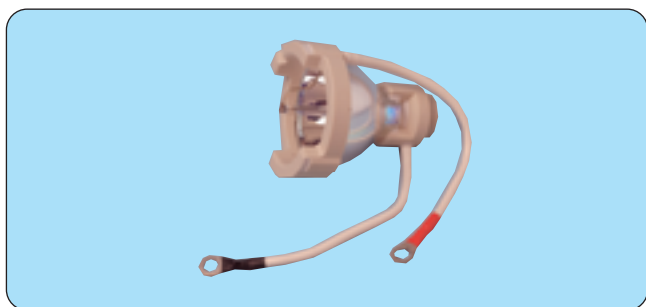

CODE STOCK PART NUMBER	RÉFÉRENCE	VOLTS	WATTS	CULOT BASE
008584	X 100/R 45 C DYO	13	100	CABLÉ
008583	HTI 250/32 DYO	45	250	SPÉCIAL

Des marques de tiers sont citées dans le présent catalogue lorsque leur référence est nécessaire pour informer ses clients de la destination de produits commercialisés par Orbitec. Ces marques restent la propriété des fabricants concernés.

C2/147

LAMPES XENON COMPACTES

Xenon compact pulse lamp for "Olympus" endoscope

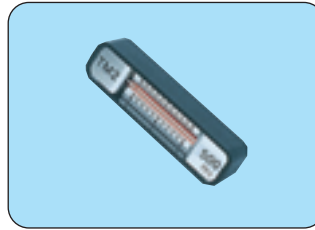

Température de couleur (° Kelvin/Color temperature) : 5 600 °K
 Durée de vie minimale/Life : 500 H
 Livré en boîte individuelle avec notice et pâte thermique (Garantie 1 an)
 L'usiomètre doit être changé à chaque remplacement d'ampoule

*Delivered in individual box with notice and thermal compound (1 year guaranty)
 Usiometer must be changed each time the bulb is replaced.*

CODE STOCK PART NUMBER	RÉFÉRENCE	WATTS	DIMENSIONS D x L (MM)
130813	X 6410	300	33 x 49
130835	X 9205	175	33 x 49
130893	KIT X 6410	LAMPE X 6410 + TM 22	

USIOMÈTRE / Usiometer

130803	TM 22	- COMPTEUR HORAIRE - SE CHANGE EN MÊME TEMPS QUE LA LAMPE CERMAX
--------	--------------	---

Pour autres lampes Xénon de la gamme, nous consulter.

For other Xenon types please consult us.

C2/148

LAMPES XENON POUR APPLICATION MEDICALE

For medical use

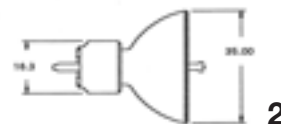
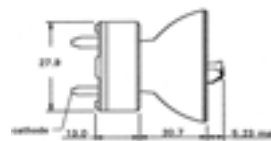
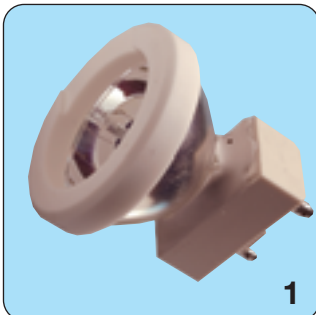

Click Below To Order

Interlight Specialty Bulbs
 1-800-743-0005
www.interlight.biz

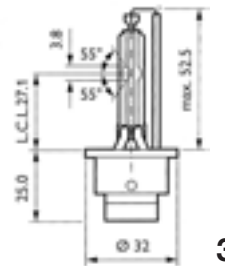
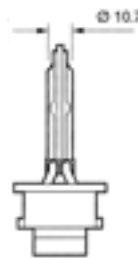

- Fibre optique/Fiber optic.

CODE STOCK PART NUMBER	RÉFÉRENCE	VOLTS	WATTS	DIMENSIONS D x L (MM)	TEMPS COUL. ° KELVIN	DURÉE DE VIE AC LIFE	FIGURE/PHOTO N°
130877	MEWA 09500	15	24	36 x 35	5 460	350	1
130891	MEWA M 24 E 001	12	24	35 x 35	5 460	350	2
130897	MDL 50	85	50	32 x 77	3 900	3 000	3

Autres produits de la gamme nous consulter.

For other types please consult us.

Third parties trademarks are mentioned in this catalogue when reference thereto is necessary to inform customers about the intended use of products sold by Orbitec. These trademarks remain the property of the manufacturers concerned.

Interlight Specialty Bulbs
1-800-743-0005
www.interlight.biz

GERMICIDE

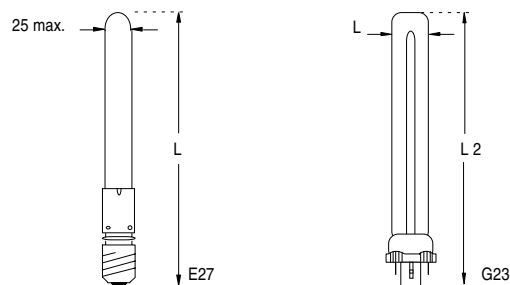
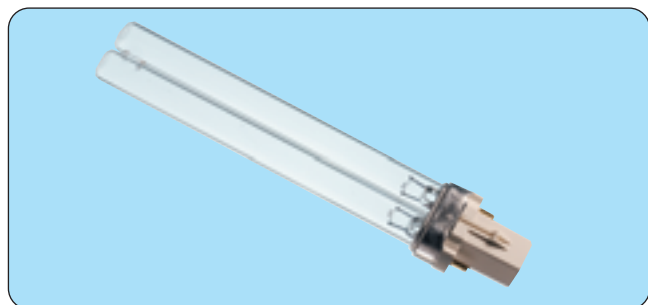

Les lampes germicides sont des lampes fluorescentes à rayonnement ultraviolet germicide, dont l'émission est dans la raie 253,7 nm. Elles doivent être par conséquent utilisées avec précaution (Exposition prolongée dangereuse). Leurs principales applications sont les suivantes : désinfection de l'air, purification de l'eau, stérilisation dans les hôpitaux et lieux publics (piscines, campings...). Fonctionnent sur ballast.

Germicidal lamps are fluorescent bulbs with ultra-violet emission around 253,7 nm. Special care in use is recommended (avoid long exposition). Recommended for air and water purification, sterilisation. Operate with ignitor.

CODE STOCK PART NUMBER	RÉFÉRENCE	VOLTS	AMPÈRE A	WATTS	DIMENSIONS D x L (MM)	DURÉE DE VIE AC LIFE
CULOT E27						
007855	XG 1065	DIRECT 220 V	0,027	6	26 x 150	2 500
CULOT G23						
007857	XG 1063	60	0,17	9	28 x 168	8 000
007858	XG 1064	91	0,16	11	28 x 238	8 000

**DECOUVREZ NOTRE GAMME DE DOUILLES, BALLASTS,
TRANSFORMATEURS ET ACCESSOIRES
DANS NOTRE NOUVEAU CATALOGUE
ECLAIRAGE ARCHITECTURAL
ET COMPOSANTS POUR
LUMINAIRES**

**A WIDE RANGE OF LAMPHOLDERS, BALLASTS,
TRANSFORMERS AND ACCESSORIES
IS NOW AVAILABLE IN OUR
ARCHITECTURAL LIGHTING
AND COMPONENTS' CATALOGUE**

Des marques de tiers sont citées dans le présent catalogue lorsque leur référence est nécessaire pour informer ses clients de la destination de produits commercialisés par Orbitec. Ces marques restent la propriété des fabricants concernés.

Interlight Specialty Bulbs
1-800-743-0005
www.interlight.biz

NICIDE
jaundice

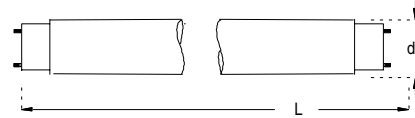

- Fonctionnement sur ballast.

ATTENTION

Emission nocive d'UVC (253,7 Nm)

En aucun cas, les yeux et les parties découvertes du corps ne doivent être soumis au rayonnement direct des lampes

(0,1 U W/cm² Max.)

- Operate with ignitor.

ATTENTION

Dangerous UVC emission (253,7 Nm)

Eyes and skin should be always protected from direct UVC Radiations

CODE STOCK PART NUMBER	RÉFÉRENCE	VOLTS	AMPÈRE	WATTS	DIMENSIONS D x L (MM)	DURÉE DE VIE AC LIFE	CULOT BASE
APPLICATION GERMICIDE / Germicidal use							
007859	XG 1067	29	0,17	4	16 x 150	8 000	G5
007856	XG 1068	42	0,16	6	16 x 226	8 000	G5
130930	XG 1070	56	0,15	8	16 x 300	8 000	G5
130932	XG 1072	56	0,32	15	26 x 440	8 000	G13
130934	XG 1074	100	0,37	30	26 x 900	8 000	G13
007860	XG 1075	105	0,43	36	26 x 1 200	8 000	G13
007861	XG 1076	83	0,785	55	26 x 900	8 000	G13
007862	XG 1077	108	0,835	75	26 x 1 200	8 000	G13
007863	XG 1078	92	1,5	115	38 x 1 200	8 000	G13
007864	XG 1079*	92	1,5	115	38 x 1 200	8 000	G13

HYPERBILIRUBINIE (JAUNISSE) / Jaundice

130944	FL 20/52	57	0,37	20	38 x 600	2 500	G13
--------	-----------------	----	------	----	----------	-------	-----

* Très haut rendement à réflecteur.

High rendering with reflector.

Third parties trademarks are mentioned in this catalogue when reference thereto is necessary to inform customers about the intended use of products sold by Orbitec. These trademarks remain the property of the manufacturers concerned.

SPECIALLES ET TECHNIQUES
SPECIAL LAMPS

Interlight Specialty Bulbs
1-800-743-0005
www.interlight.biz

G13 / R17D POUR NEGATOSCOPE

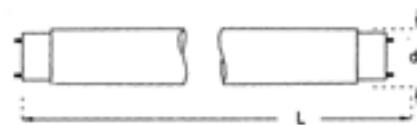
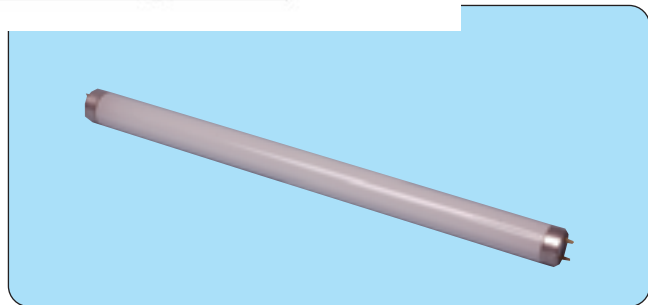

Application : visualisation des clichés en radiologie
- Autre tube sur demande / For X-Ray print outs. Other tubes available on request

CODE STOCK PART NUMBER	RÉFÉRENCE	WATTS	TEMPS COUL. ° KELVIN	DIMENSIONS D x L (MM)
G13 - IRC 85 (LUMIÈRE DU JOUR/Daylight)				
007730	FL 1092	14	6 500	26 x 360
007653	FL 1016	15	6 200	26 x 438
007681	FL 1019	25	6 500	26 x 818
007983	FL 1003	30	6 500	26 x 895
008229	FL 1156 PH	36	6 500	26 x 1 200
007792	FL 1240	40	6 500	38 x 1 200
008008	FL 1157	58	6 000	26 x 1 500
007670	FL 1062	58	6 500	26 x 1 500
G10Q CIRCULAIRE (LUMIÈRE DU JOUR/Daylight) - Circular shape				
007865	FL1284	22	6 500	29 x 216
007844	FL1283*	22	4 000	29 x 216
007866	FL1288	32	6 500	32 x 307
007867	FL1296	40	6 500	32 x 409

* Blanc Industrie/Cool white.

C2/152

G13/R17D POUR PHOTOTHERAPIE
For Phototherapy

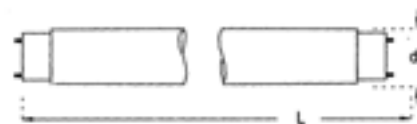
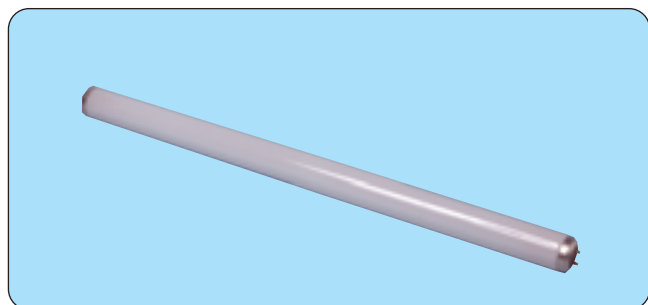

Applications thérapeutiques / Therapeutic applications.

CODE STOCK PART NUMBER	RÉFÉRENCE	VOLTS	AMPÈRE	WATTS	DIMENSIONS D x L (MM)	DURÉE DE VIE AC LIFE	CULOT BASE
130944	FL 20/52	57	0,37	20	38 x 600	2 500	G13

Des marques de tiers sont citées dans le présent catalogue lorsque leur référence est nécessaire pour informer ses clients de la destination de produits commercialisés par Orbitec. Ces marques restent la propriété des fabricants concernés.

Interlight Specialty Bulbs
1-800-743-0005
www.interlight.biz

RAYONNEMENT A DECHARGE TYPE "ULTRA-VITALUX"

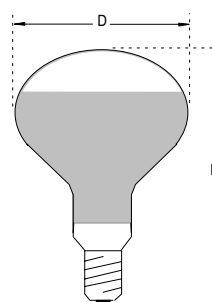

Lampe aux vapeurs de mercure haute pression à rayonnement ultraviolet et infrarouge compris entre 250 et 2 000 nm. Utilisée principalement en dermatologie, traitements médicaux...

High pressure mercury lamps with ultraviolet and infra-red rays between 250 and 2 000 nm. Used in dermatology, medical diagnostic

CODE STOCK PART NUMBER	RÉFÉRENCE	VOLTS	WATTS	DIMENSIONS/SIZE D x L (MM)	VERRE GLASS
008640	SP 1040	230	300	127 x 185	DÉPOLI/FROSTED

C2/154

E27 INFRAROUGE TYPE "THERATHERM"

Type "THERATHERM"

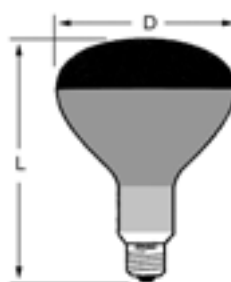

Application : thermothérapie chimique, rééducation musculaire, soins de beauté (traitement de la peau)

Used for: chemical thermotherapy, muscular re-habilitation, beauty skin care.

CODE STOCK PART NUMBER	RÉFÉRENCE	VOLTS	WATTS	DIMENSIONS D x L (MM)	VERRE GLASS
008631	SP 1031	230	300	127 x 185	DÉPOLI ROUGE/RED

C2/155

KY10S AUX HALOGENES METALLIQUES TYPE "ULTRAMED"

"ULTRAMED"/Metal halide type

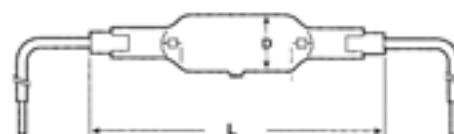
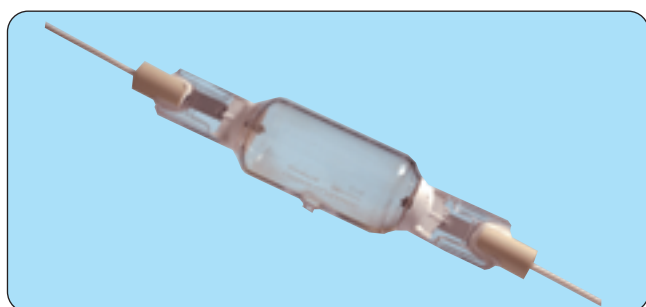

Application : cosmétique, dermatologie. A utiliser avec des filtres UV, préconisés par le fabricant de l'appareil.

Use for cosmetics/Dermatology
To be used with UV filters as per equipment's Manufacturer notice.

CODE STOCK PART NUMBER	RÉFÉRENCE	VOLTS	WATTS	DIMENSIONS D x L (MM)
130819	H 1000	130	1 000	28 x 141

Third parties trademarks are mentioned in this catalogue when reference thereto is necessary to inform customers about the intended use of products sold by Orbitec. These trademarks remain the property of the manufacturers concerned.

SPECIALLES ET TECHNIQUES SPECIAL LAMPS