

Contactron



Produit de l'année 2008

Contacteur électronique

CONTACTRON – “4 en 1”

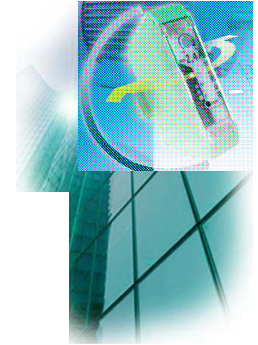

Rapide et sans usure

2 versions 2 A et 9 A (1 kW / 4 kW)

Commande droite et gauche,
Protection thermique moteur
Coupure d'arrêt d'urgence

LED d'état

10⁷ cycles électriques !



Dimensions 99 x **22,5** x 114,5 mm

Contacteur électronique

CONTACTRON – “4 en 1”

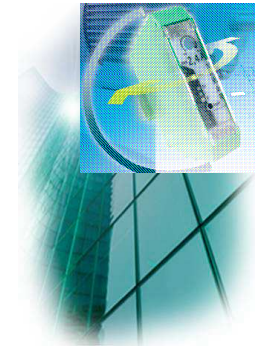

22,5 mm

135 - 180 mm



=



+



+



Contacteurs inverseurs

+

Protection moteur

+

contacteur arrêt d'urgence

Contactron - Puissance

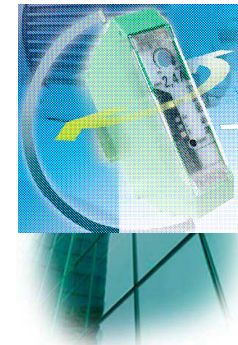

Câblage classique

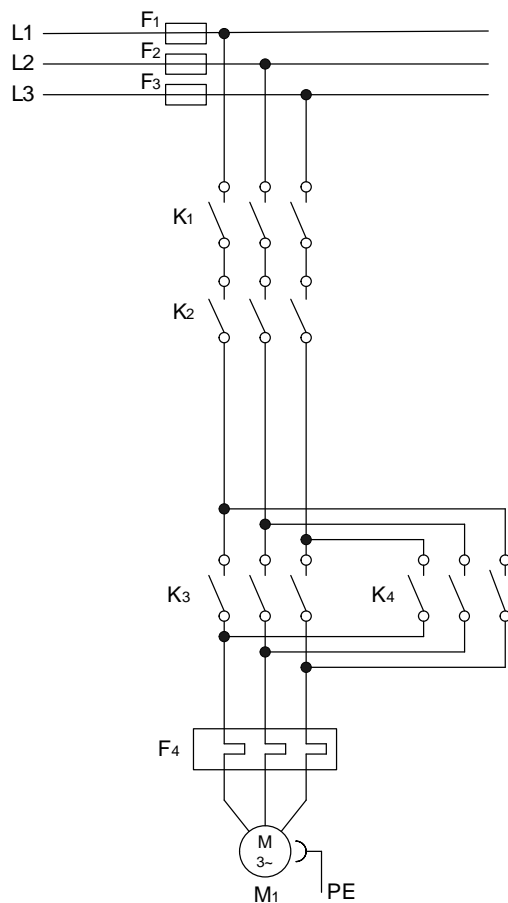

Câblage Contactron

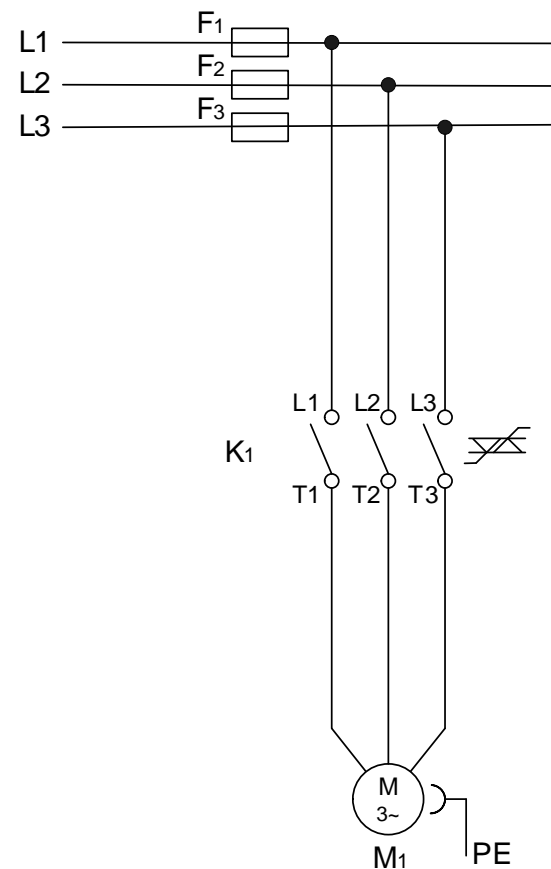

Contactron - Commande

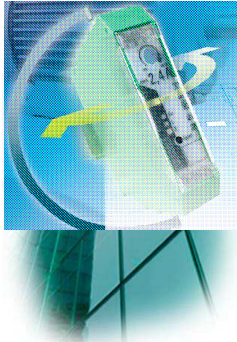

Câblage classique

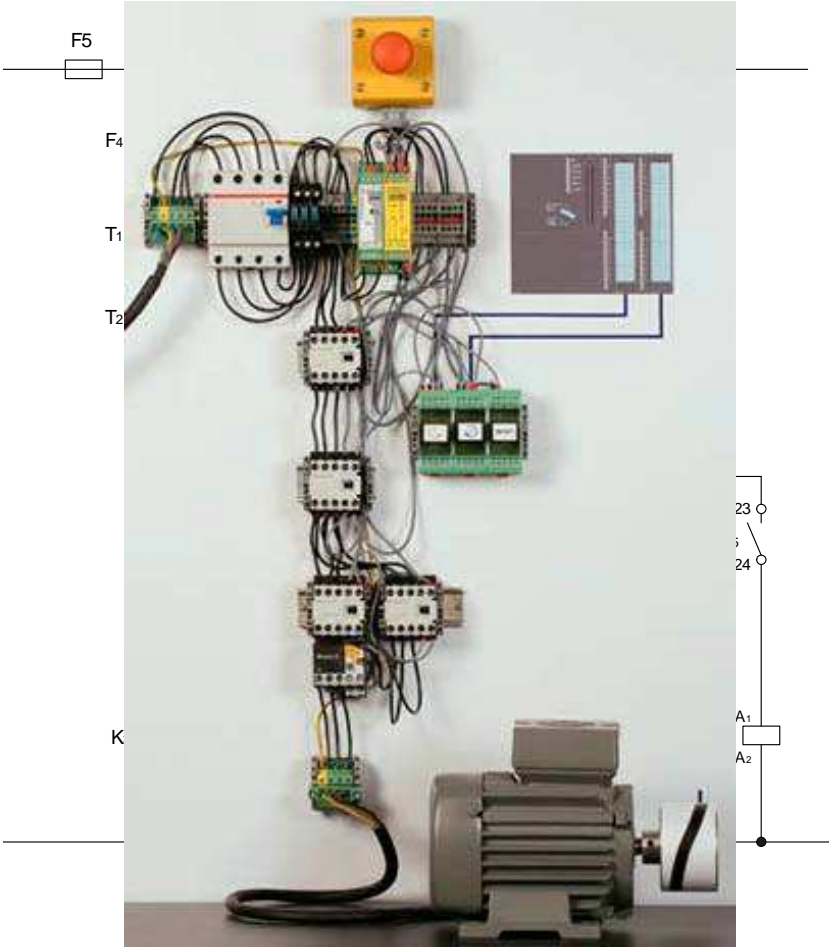

Câblage Contactron

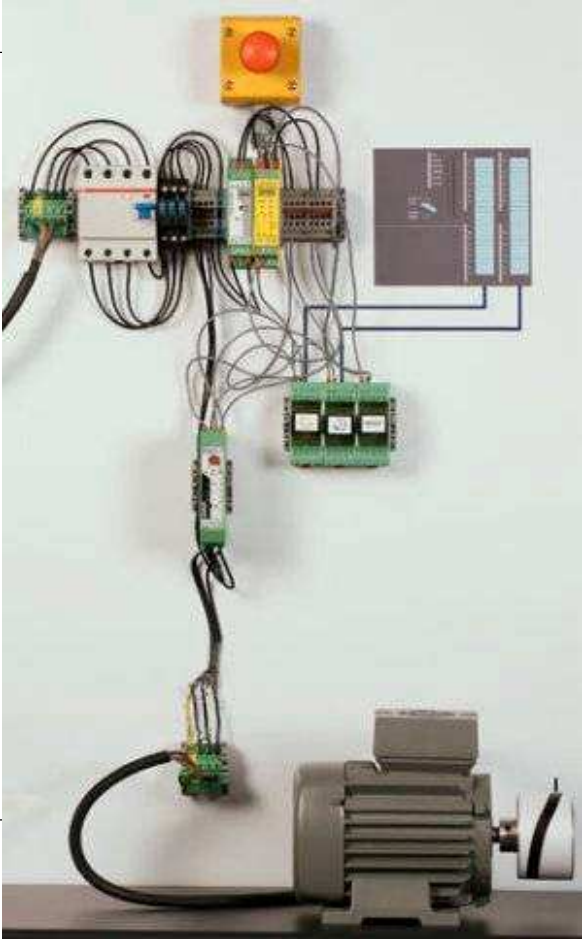

Contactron



- Comparaison des temps de câblage

	contacteurs standard	CONTACTRON
Circuit principal	10 minutes	5 minutes
Circuit commande	11 minutes	5 minutes
Total	21 minutes	10 minutes