

Simple Fiber Amplifiers

E3X-SD/NA Series



Simplicity and High Performance

The Series now includes models with digital displays and direct key setting.

NEW Digital Display – Direct Key Setting

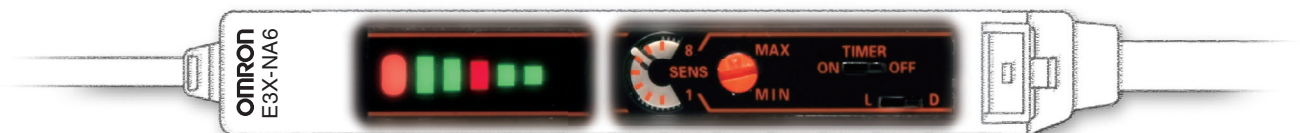
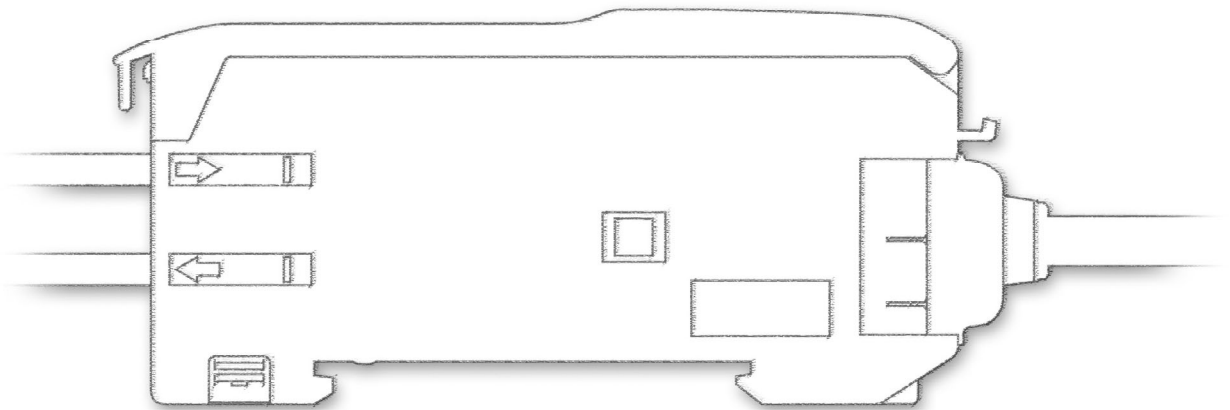

Bar Display – Manual Setting

Simplicity and High Performance

1

Operation and Displays So Simple That Anyone Can Use the Amplifier Right Away

A design that focuses on simple operation has resulted in an Amplifier that is so simple it can be operated without the manual.

The Amplifier also uses a large, easy-to-read operation indicator and a simple display for excess gain (i.e., incident level/operating level).

Essentially anyone can use the Amplifier right away. **No manual**

Setting is completed with a single press when teaching with/without the workpiece.

No screwdriver

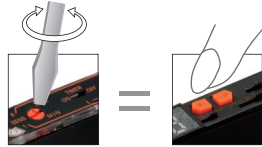

Fine adjustments can be made in increments of 1% using the Up and Down Keys.

E3X-SD

10 mm

Fine tuning can be performed using the 8-turn adjuster (with indicator).

E3X-NA

Compact

Small body with width of 10 mm and simple operation.

Compact size with length of 65 mm.

No modes

A timer function is provided as a standard feature.

The switch is for the timer only, so no complicated operation is required.

Largest display in the industry = 6 mm

Intuitive display for excess gain (i.e., incident level/operating level)

Large, easy-to-read operation indicator

Stable incident light

Stable light interruption

Operating level

999%

120%

110%

100%

90%

80%

0%

Large bar display with five levels: 80%, 90%, 100%, 110%, and 120%

Immediately determine operation and amount of light with a simple, bright display.

With the E3X-SD, settings and management can be performed reliably using the digital display ranging from 0% to 999% (10 times), and with the E3X-NA, the same can be performed intuitively using the large 5-level bar display.

2

Wire-saving Connector to Reduce Work and Stock Management

Gang-mount up to 16 Amplifiers.

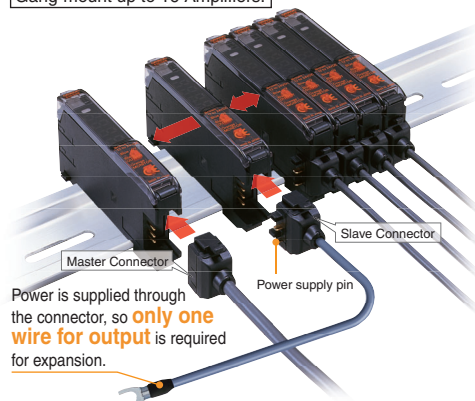

- Large reduction in wiring work
- Simple management: No distinction between master and slaves

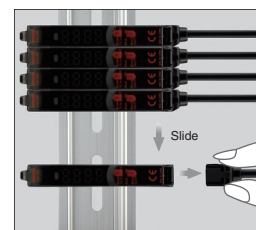

Work efficiency is also improved during maintenance.

3

General-purpose Performance for Simple Use

The three most important performance capabilities when selecting a sensor are achieved to a high standard: distance, speed, and precision.

A balance is provided between reliable detection performance and capability for a broad range of applications.

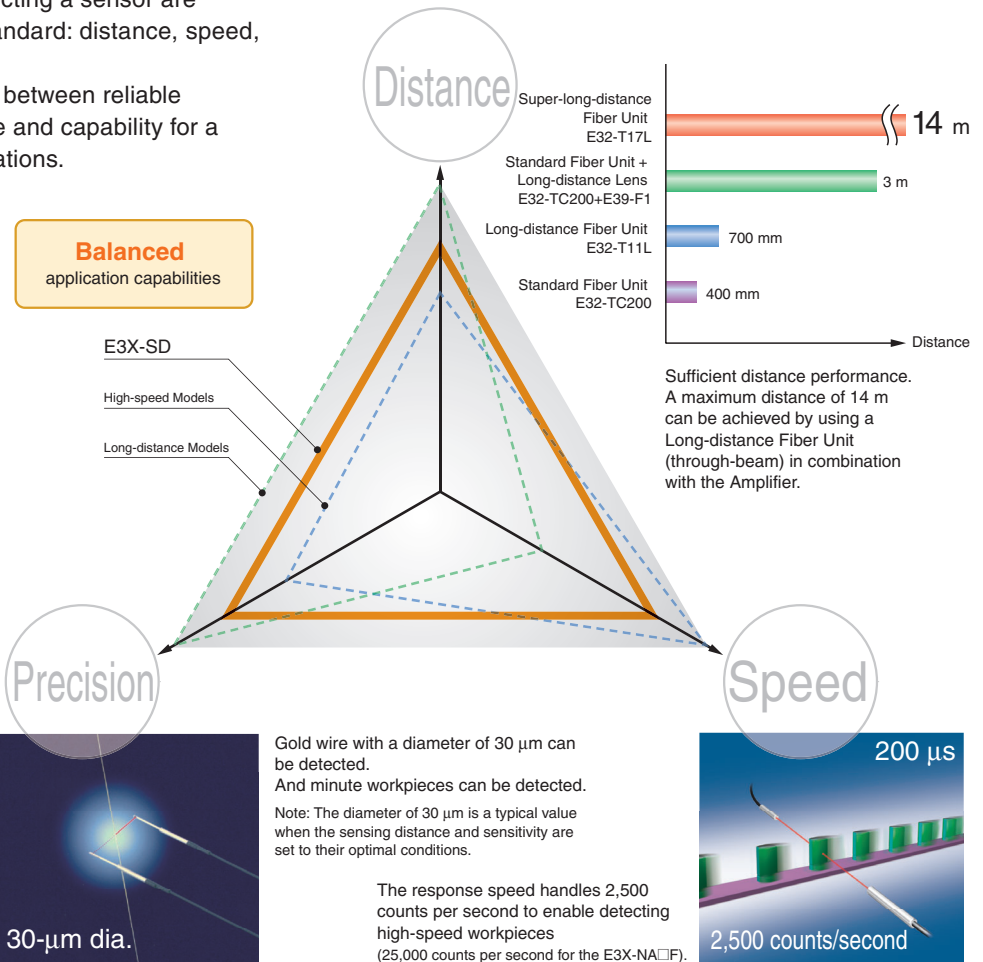

4

Optical Communications to Prevent Mutual Interference for Up to Five Amplifiers

Optical communications is used between Amplifiers.

Interference is reliably prevented for up to five Amplifiers by mutually staggering the light emission timing (except for the E3X-NA□F).

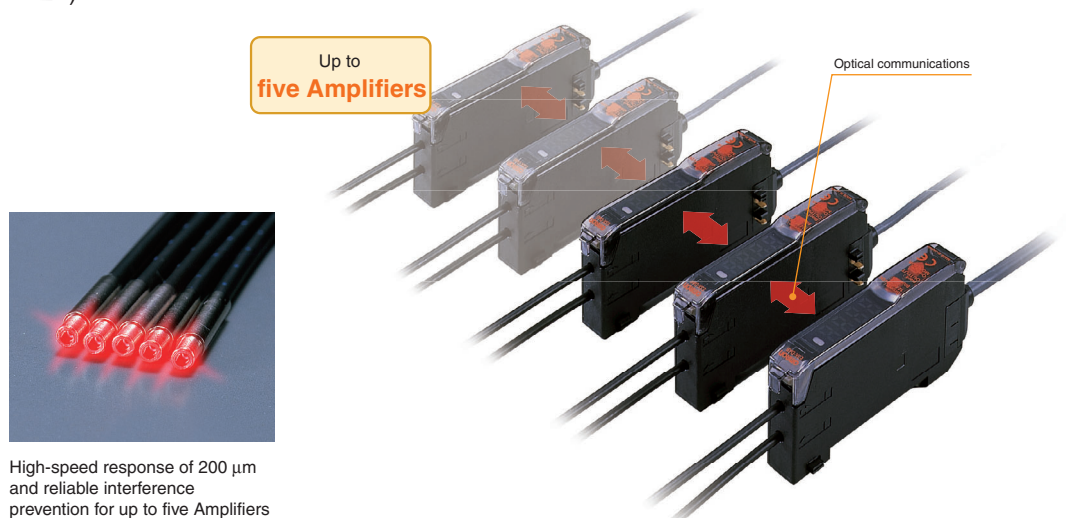

Selecting Fiber Amplifiers

Simple

For simple operation: Select a Simple Fiber Amplifier.

Standard Amplifiers

NEW

Reliable

Digital display and direct setting

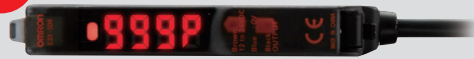

E3X-SD□

Intuitive

Bar display and adjuster setting



E3X-NA□

Fastest in class

Super-high-speed Amplifiers (20 μs)

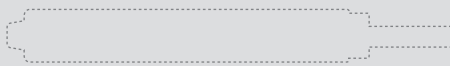

E3X-NA□F

Water-resistant Amplifiers (IP66)

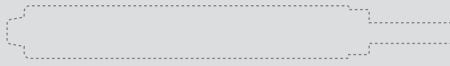

E3X-NA□V

All in One

For multifunctional capability: Select an Advanced Fiber Amplifier.

Standard Amplifiers



E3X-DA□-S

Standard models

E3X-DA□AN-S

Easy measurement control using analog output

Advanced Amplifiers



E3X-DA□TW-S

Range determination using twin outputs

E3X-DA□RM-S

Sensor control using external signal

E3X-DA□AT-S

World's first Reliable operation in dust using automatic threshold control.

Two-channel Amplifiers



E3X-MDA□

New concept Save space with two Amplifiers packed into a single case.

Color-sensing Amplifiers

NEW



E3X-DAC□-S

World's first Color sensing models with white LEDs
Stable detection with resistance against workpiece movement.

Simple Fiber Amplifier

E3X-SD/-NA

The Standard for Fiber Amplifiers with Simple Operation and High Performance

- Operation so simple that essentially anyone can use the amplifier right way.
- Immediately determine operation and amount of light with a simple, bright display.
- General-purpose capabilities to simply handle a broad range of applications.



Ordering Information

Amplifier Units

Digital Display and Direct Key Setting

Item	Appearance	Connection method	Ratings and Specifications	Model	
				NPN output	PNP output
Standard models		Pre-wired	---	E3X-SD11	E3X-SD41
		Wire-saving connector		E3X-SD6	E3X-SD8

Bar Display and Adjuster Setting

Item	Appearance	Connection method	Ratings and Specifications	Model	
				NPN output	PNP output
Standard models		Pre-wired	---	E3X-NA11	E3X-NA41
		Wire-saving connector		E3X-NA6	E3X-NA8
High-speed detection models		Pre-wired	Response time: 20 μs	E3X-NA11F	E3X-NA41F
Water-resistant models		Pre-wired	Degree of protection: IP66	E3X-NA11V	E3X-NA41V
		Connector (M8)		E3X-NA14V	E3X-NA44V

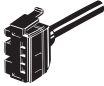
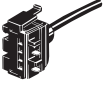

E3X-SD/-NA

Amplifier Unit Connectors (Order Separately) Note: Stickers for Connectors are included as accessories.

Item	Appearance	Cable length	No. of conductors	Model
Master Connector		2 m	3	E3X-CN11
Slave Connector			1	E3X-CN12

Combining Amplifier Units and Connectors <small>(Basically, Amplifier Units and Connectors are sold separately) Refer to the following tables when placing an order.</small>	Amplifier Units			+	Applicable Connectors (Order Separately)	
	Type	NPN	PNP		Master Connector	Slave Connector
	Standard models	E3X-SD6 E3X-NA6	E3X-SD8 E3X-NA8		E3X-CN11 (3-wire)	E3X-CN12 (1-wire)
When Using 5 Amplifier Units				+	1 Master Connector + 4 Slave Connectors	
5 Amplifier Units						

Sensor I/O Connectors (Order Separately)

Size	Cable specifications	Appearance	Cable type	Model	
M8	Standard cable	Straight connector 	2 m	Four-conductor cable	XS3F-M421-402-A
			5 m		XS3F-M421-405-A
		L-shaped connector 	2 m		XS3F-M422-402-A
			5 m		XS3F-M422-405-A

Accessories (Order Separately)

Mounting Brackets

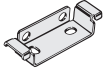
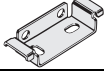
Appearance	Applicable models	Model	Quantity
	E3X-SD□ E3X-NA□ E3X-NA□F	E39-L143	1
	E3X-NA□V	E39-L148	

End Plate

Appearance	Model	Quantity
	PFP-M	1

Ratings and Specifications

Amplifier Units

Item	Type Model	Digital display and direct key setting		Bar display and adjuster setting		
		Standard models		Standard models	High-speed detection models	Water-resistant models
		E3X-SD□		E3X-NA□	E3X-NA□F	E3X-NA□V
Light source (wavelength)	Red LED (620 nm)		Red LED (680 nm)			
Power supply voltage	12 to 24 VDC ±10%, ripple (p-p): 10% max.					
Current consumption	960 mW max. (Power supply: 24 V, Current consumption: 40 mA max.)		35 mA max.			
Control output	Open-collector output (NPN or PNP) Load power supply: 26.4 V max., Load current: 50 mA max. (Residual voltage: 1.5 V max.) (*1) Light-ON/Dark-ON mode selector					
Response time	Operate or reset: 200 μs max. (*2)			Operate: 20 μs max. Reset: 30 μs max.	Operate or reset: 200 μs max. (*2)	
Sensitivity adjustment	UP/DOWN direct key setting, teaching		8-turn sensitivity adjuster (with indicator)			
Protection circuits	Power supply reverse polarity protection, output short-circuit protection, output reverse polarity protection (*3)					
Timer function	ON/OFF-delay timer: 10 ms (each fixed)		OFF-delay timer: 40 ms (fixed)			
Mutual interference prevention	Up to 5 Amplifiers (optically synchronized)			None	Up to 5 Amplifiers (optically synchronized)	
Ambient illumination	Receiver side Incandescent lamp: 10,000 lux max. Sunlight: 20,000 lux max.					
Ambient temperature range	Operating: Groups of 1 to 3 Amplifiers: -25°C to 55°C Groups of 4 to 11 Amplifiers: -25°C to 50°C Groups of 12 to 16 Amplifiers: -25°C to 45°C Storage: -30°C to 70°C (with no icing or condensation)					
Ambient humidity range	Operating and storage: 35% to 85% (with no condensation)					
Insulation resistance	20 MΩ min. (at 500 VDC)					
Dielectric strength	1,000 VAC at 50/60 Hz for 1 minute (*4)					
Vibration resistance	Destruction: 10 to 55 Hz with a 1.5-mm double amplitude for 2 hrs each in X, Y and Z directions					
Shock resistance	Destruction: 500 m/s ² , for 3 times each in X, Y and Z directions					
Degree of protection	IEC 60529 IP50 (with Protective Cover attached)				IEC 60529 IP66 (with Protective Cover attached)	
Connection method	Pre-wired (standard cable length: 2 m), or connector					
Weight (packed state)	Pre-wired model: Approx. 100 g, Model with connector: Approx. 55 g (*5)					
Material	Case	Polybutylene terephthalate (PBT)				
	Cover	Polycarbonate			Polyethersulfone (PES)	
Accessories	Instruction manual					

*1. For the E3X-NA, residual voltage is 1 V max.

*2. When there are 8 or more E3X-NA Amplifiers mounted side-by-side, the response time will be 350 μs max.

*3. The E3X-NA does not have output reverse polarity prevention.

*4. Water-resistant models and models with connectors have a dielectric strength of 500 VAC.

*5. Add 10 g for water-resistant models.

Amplifier Unit Connectors

Item	Model	E3X-CN11	E3X-CN12
Rated current	2.5 A		
Rated voltage	50 V		
Contact resistance	20 mΩ max. (20 mVDC max., 100 mA max.) (The above figure is for connection to the Amplifier Unit and the adjacent Connector. It does not include the conductor resistance of the cable.)		
Number of insertions	Destruction: 50 times (for connection to the Amplifier Unit and the adjacent Connector)		
Material	Housing	Polybutylene terephthalate (PBT)	
	Contact	Phosphor bronze/gold-plated nickel	
Weight (packed state)	Approx. 55 g		Approx. 25 g

E3X-SD/-NA

Fiber Unit Overview

No snagging, no breaking:
Right-angle (L-shaped) Models



Feature 1 | L-shaped Attachment

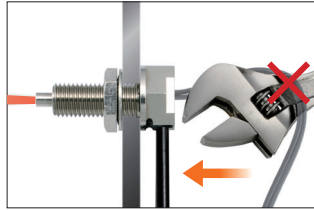

No snagging during maintenance. Fiber flexibility prevents breaking.

Feature 2 | New Head Shape

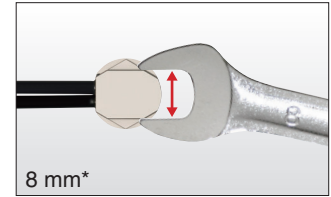
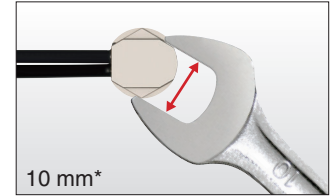

Convenient design accommodates two wrench sizes. Allows quick tightening.

*For M6 models.

Flat and flexible fiber models are easy to mount and will not break.

Reflective Fiber Units

Flat View
E32-D15ZR

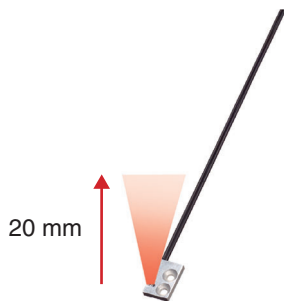

Size: 15 × 10 × 3 mm

Feature | No Breaking

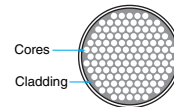
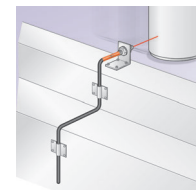
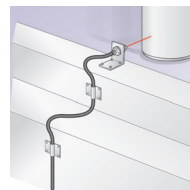

A large number of ultrafine cores are all surrounded by cladding. As a result, the fiber is flexible and can be bent without significantly reducing the light intensity. This helps solve problems, such as fiber being broken by getting caught on other objects.

Through-beam Fiber Units

Top View
E32-T15XR

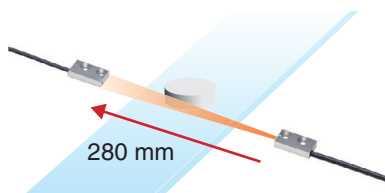

Size: 15 × 8 × 3 mm

Side View
E32-T15YR

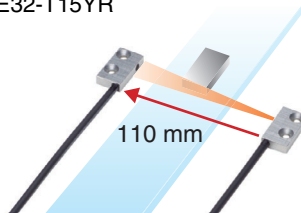

Flat View
E32-T15ZR

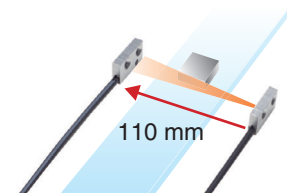

Sensing Distance Through-beam Models

(Unit: mm)

Type		Model	E3X-SD□ E3X-NA□	E3X-NA□F
			Standard models	High-speed detection models
Standard models	Flexible (new standard)	E32-T11R/E32-T12R/E32-T15XR/E32-TC200BR (B4R)	280	80
		E32-T14LR/E32-T15YR/E32-T15ZR	110	33
		E32-T21R/E32-T22R/E32-T222R/E32-T25XR/E32-TC200FR (F4R)	60	18
		E32-T24R/E32-T25YR/E32-T25ZR	30	9
	Standard	E32-TC200/E32-T12/E32-T15X/E32-TC200B (B4)	400	120
		E32-T14L/E32-T15Y/E32-T15Z	240	70
		E32-TC200A	360	100
		E32-TC200E/E32-T22/E32-T222/E32-T25X/E32-TC200F (F4)	100	30
	Break resistant	E32-T24/E32-T25Y/E32-T25Z	90	27
		E32-T11/E32-T12B/E32-T15XB	360	100
		E32-T21/E32-T221B/E32-T22B	100	30
	Fluorine coating	E32-T25XB	75	20
		E32-T11U	360	100
Special-beam models	Long distance, high power	E32-T17L	14000	4200
		E32-TC200 + E39-F1	3000	900
		E32-T11R + E39-F1	2100	630
		E32-T11 + E39-F1	2000	600
		E32-T14	1800	540
		E32-T11L/E32-T12L	700	210
		E32-T11L + E39-F2	500	150
		E32-T11R + E39-F2	220	65
		E32-T11 + E39-F2	360	100
		E32-T21L/E32-T22L	200	60
	Ultracompact, ultrafine sleeve	E32-T223R	60	18
		E32-T33-S5	20	6
		E32-T333-S5	5	1.5
		E32-T334-S5	2.5	0.8
	Fine beam (narrow vision field)	E32-T22S	1000	300
		E32-T24S	700	210
	Area sensing	E32-T16PR	450	130
		E32-T16P	600	180
		E32-T16JR	390	110
		E32-T16J	520	150
		E32-T16WR	690	200
		E32-T16W	920	270
		E32-T16	1500	450
E32-M21		300	90	
Environment resistive models	Heat resistant	E32-T51	400	120
		E32-T54	130	35
		E32-T81R-S	180	50
		E32-T61-S + E39-F2	390	130
		E32-T61-S + E39-F1	3000	900
		E32-T84S-S	700	210
		E32-T61-S	300	90
	Chemical resistant	E32-T11F	1050	380
		E32-T12F	1600	480
		E32-T14F	200	60
		E32-T51F	700	200
		E32-T81F-S	350	100
	Vacuum resistant	E32-T51V	100	---
		E32-T51V + E39-F1V	600	---
		E32-T54V	65	---
		E32-T54V + E39-F1V	390	---
		E32-T84SV	250	---

For information on Fiber Units, refer to the *E32 Series Fiber Sensor Best Selection* (Cat. No. E354).

E3X-SD/-NA

Reflective Models

(Unit: mm)

Type		Model	E3X-SD□ E3X-NA□	E3X-NA□F	
			Standard models	High-speed detection models	
Standard models	Flexible (new standard)	E32-D11R/E32-D12R/E32-D15XR/E32-DC200BR (B4R)	90	30	
		E32-D14LR	16	5	
		E32-D15YR/E32-D15ZR	20	5	
		E32-D211R/E32-D21R/E32-D22R/E32-D25XR/ E32-DC200FR (F4R)	15	5	
		E32-D24R	7	2.3	
		E32-D25YR/E32-D25ZR	4	1.2	
	Standard	E32-DC200/E32-D15X/E32-DC200B (B4)	150	50	
		E32-D12	120	40	
		E32-D14L	40	13	
		E32-D15Y/E32-D15Z	50	15	
		E32-D211/E32-DC200E/E32-D22/E32-D25X/ E32-DC200F (F4)	36	12	
		E32-D24	15	5	
	Break resistant	E32-D25Y/E32-D25Z	10	3.3	
		E32-D11/E32-D15XB	90	30	
		E32-D21B/E32-D221B	35	10	
		E32-D21/E32-D22B	15	5	
	Fluorine coating	E32-D25XB	25	8	
		E32-D11U	90	30	
	Special-beam models	Long distance, high power	E32-D16	40 to 400	55 to 70
			E32-D11L	200	65
E32-D21L/E32-D22L			50	17	
Ultracompact, ultrafine sleeve		E32-D33	10	3.3	
		E32-D331	1.5	0.5	
Coaxial, small spot		E32-CC200R	75	25	
		E32-CC200	150	50	
		E32-D32L	80	25	
		E32-C31/E32-D32	40	13	
		E32-C42 + E39-F3A	Spot diameter of 0.1 to 0.6 mm at 6 to 15 mm.		
		E32-D32 + E39-F3A	Spot diameter of 0.5 to 1 mm at 6 to 15 mm.		
		E32-C41 + E39-F3A-5	Spot diameter of 0.1 mm at 7 mm.		
		E32-C31 + E39-F3A-5	Spot diameter of 0.5 mm at 7 mm.		
		E32-C41 + E39-F3B	Spot diameter of 0.2 mm at 17 mm.		
		E32-C31 + E39-F3B	Spot diameter of 0.5 mm at 17 mm.		
E32-C31 + E39-F3C		Spot diameter of 4 mm max. at 0 to 20 mm.			
Area sensing		E32-D36P1	75	25	
Retro-reflective		E32-R21 + E39-R3 (provided)	10 to 250		
		E32-R16 + E39-R1 (provided)	150 to 1500	150 to 1000	
Convergent-reflective		E32-L25/E32-L25A	3.3		
		E32-L24S	0 to 4		
		E32-L24L	2 to 6 (center 4)		
		E32-L25L	5.4 to 9 (center 7.2)		
	E32-L86	4 to 10			
	E32-L16	0 to 15	0 to 13		
Environment resistive models	Heat resistant	E32-D51	120	40	
		E32-D81R/E32-D61	45	15	
		E32-D73	30	10	
	Chemical resistant	E32-D12F	50	16	
		E32-D14F	20	6.5	

For information on Fiber Units, refer to the *E32 Series Fiber Sensor Best Selection* (Cat. No. E354).

I/O Circuit Diagrams

Output form	Model	Output transistor operation mode	Timing charts	Operation selector	Output circuit
NPN Output	E3X-SD11 E3X-SD6 E3X-NA11 E3X-NA6 E3X-NA11F E3X-NA11V E3X-NA14V	Light-ON		LIGHT ON (L-ON)	<p>• M8 Connector Pin Arrangement </p> <p>Note: Pin 2 is not used.</p> <p>*Not present on the E3X-NA.</p>
		Dark-ON		DARK ON (D-ON)	<p>• M8 Connector Pin Arrangement </p> <p>Note: Pin 2 is not used.</p> <p>*Not present on the E3X-NA.</p>
PNP Output	E3X-SD41 E3X-SD8 E3X-NA41 E3X-NA8 E3X-NA41F E3X-NA41V E3X-NA44V	Light-ON		LIGHT ON (L-ON)	<p>• M8 Connector Pin Arrangement </p> <p>Note: Pin 2 is not used.</p> <p>*Not present on the E3X-NA.</p>
		Dark-ON		DARK ON (D-ON)	<p>• M8 Connector Pin Arrangement </p> <p>Note: Pin 2 is not used.</p> <p>*Not present on the E3X-NA.</p>

Note: Timing Charts for Timer Settings (T: Set Time)

ON delay	OFF delay

Plug (Sensor I/O Connector)

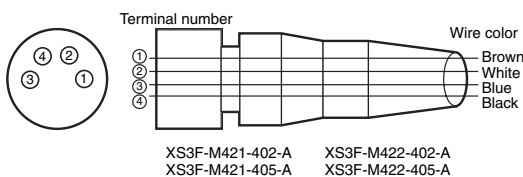

Classification	Wire color	Connection pin	Application
DC	Brown	1	Power supply (+V)
	White	2	---
	Blue	3	Power supply (0 V)
	Black	4	Output

Note: Pin 2 is not used.

E3X-SD/-NA

Nomenclature

Amplifier Units

E3X-SD

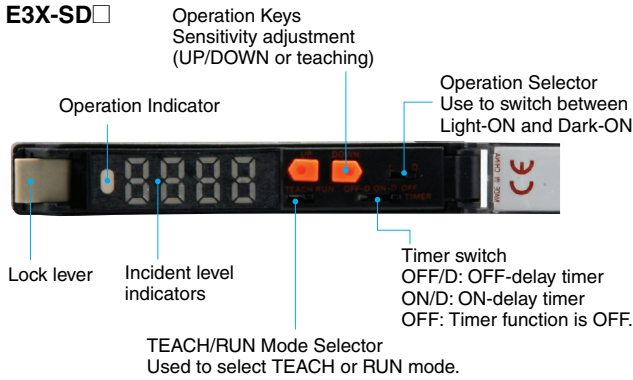

E3X-NA

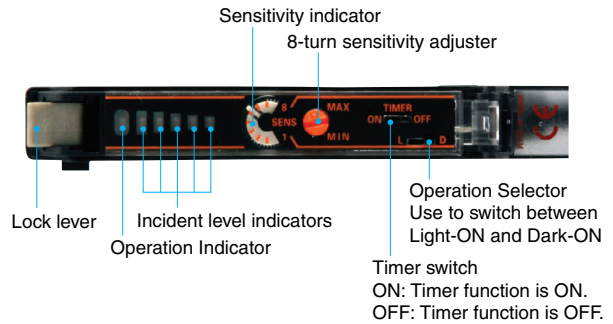

Safety Precautions

WARNING

This product is not designed or rated for ensuring safety of persons either directly or indirectly.

Do not use it for such purposes.



Caution

Do not exceed the rated voltage. Excess voltage may result in malfunction or fire.



Do not use an AC power supply. Using an AC power supply may result in rupturing.



High-temperature environments may result in burn injury.



Precautions for Safe Use

The following precautions must be observed to ensure safety.

1. Do not use the product in locations where flammable or explosive gas is present.
2. Do not use the product in locations subject to splashing water, oil, or chemicals, or in locations subject to steam.
3. Do not attempt to disassemble, repair, or modify the product.
4. Do not apply voltage or current in excess of the rated ranges.
5. Do not use the product in atmospheres or environments that exceed product ratings.
6. Do not wire the product incorrectly, such as using incorrect power supply polarity.
7. Connect the load properly.
8. Do not short-circuit both ends of the load.
9. Do not use the product if the case is damaged.
10. When disposing of the product, dispose of it as industrial waste.
11. Do not use the product in locations subject to direct sunlight.
12. The surface temperature of the product may rise as a result of the ambient temperature, power supply, or other usage conditions. Use caution when performing maintenance and washing. Failure to do so may result in burn injury.

Precautions for Correct Use

Do not use the product in atmospheres or environments that exceed product ratings.

Amplifier Units

● Designing

Communications Hole

The hole on the side of the Amplifier Unit is a communications hole for preventing mutual interference when Amplifier Units are mounted side-by-side. The E3X-MC11 Mobile Console (order separately) cannot be used.

If an excessive amount of light is received via the Sensor, the mutual interference prevention function may not work. In this case, make the appropriate adjustments using the sensitivity adjuster.

The mutual interference prevention function will not operate when the E3X-SD/NA is used side-by-side with E3X-DA-N models.

● Mounting

DIN Track Mounting/Removal

Mounting Amplifier Units

1. Mount the Amplifier Units one at a time onto the DIN track.

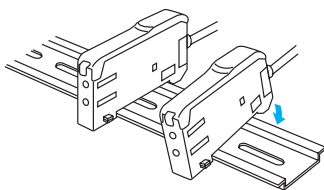

2. Slide the Amplifier Units together, line up the clips, and press the Amplifier Units together until they click into place.

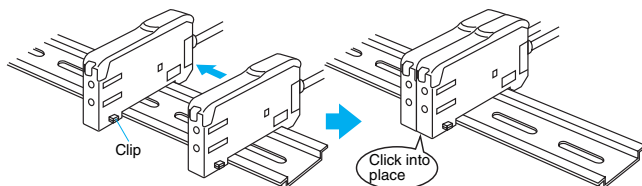

Removing Amplifier Units

Slide Amplifier Units away from each other, and remove from the DIN track one at a time. (Do not attempt to remove Amplifier Units from the DIN track without separating them first.)

- Note 1.** The specifications for ambient temperature will vary according to the number of Amplifier Units used together. For details, refer to *Ratings and Specifications*.
- 2.** Always turn OFF the power supply before mounting or removing Amplifier Units.

Fiber Connection and Disconnection

The E3X Amplifier Unit has a lock lever. Connect or disconnect the fibers to or from the E3X Amplifier Unit using the following procedures:

1. Connection

Open the Protective Cover, insert the fibers according to the fiber insertion marks on the side of the Amplifier Unit, and lower the lock lever.

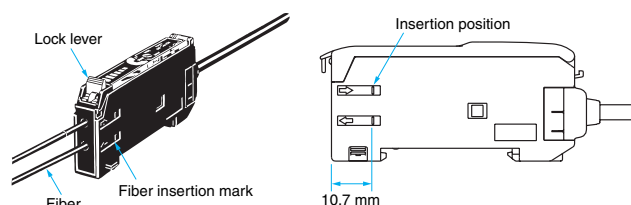

2. Disconnection

Remove the Protective Cover and raise the lock lever to pull out the fiber.

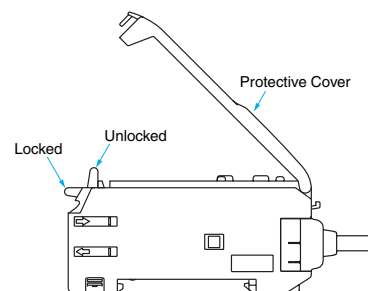

Note: To maintain the fiber properties, confirm that the lock is released before removing the fiber.

3. Precautions for Fiber Connection/Disconnection

Be sure to lock or unlock the lock lever within an ambient temperature range between -10°C and 40°C .

● Operating Environment

Ambient Conditions

If dust or dirt adhere to the hole for optical communications, it may prevent normal communications. Be sure to remove any dust or dirt before using the Units.

● Other

Protective Cover

Be sure to mount the Protective Cover before use.

Amplifier Units with Connectors

● Mounting

Mounting Connectors

1. Insert the Master or Slave Connector into the Amplifier Unit until it clicks into place.

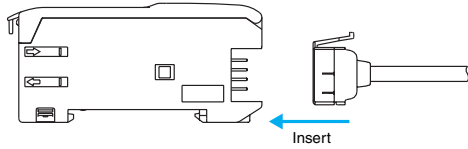

2. Join Amplifier Units together as required after all the Master and Slave Connectors have been inserted.
3. Attach the stickers (provided as accessories) to the sides of Master and Slave Connectors that are not connected to other Connectors.

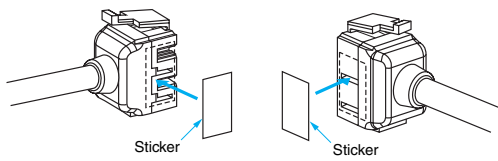

Note: Attach the stickers to the sides with grooves.

Removing Connectors

1. Slide the slave Amplifier Unit for which the Connector is to be removed away from the rest of the group.
2. After the Amplifier Unit has been separated, press down on the lever on the Connector and remove it. (Do not attempt to remove Connectors without separating them from other Amplifier Units first.)

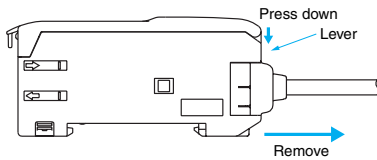

Mounting End Plate (PFP-M)

Depending on how it is mounted, an Amplifier Unit may move during operation. In this case, use an End Plate. Before mounting an End Plate, remove the clip from the master Amplifier Unit using a nipper or similar tool.

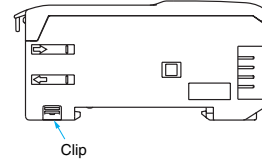

The clip can also be removed using the following mechanism, which is incorporated in the construction of the section underneath the clip.

1. Insert the clip to be removed into the slit underneath the clip on another Amplifier Unit.

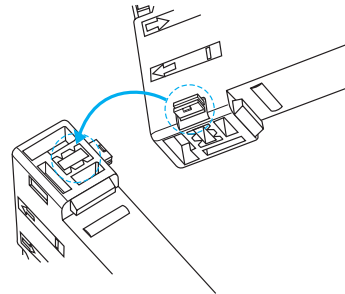

2. Remove the clip by rotating the Amplifier Unit.

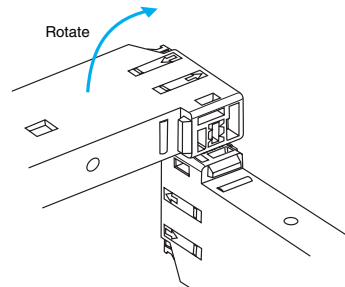

Pull Strengths for Connectors (Including Cables)

E3X-CN11: 30 N max.

E3X-CN12: 12 N max.

Dimensions

Amplifier Units

Amplifier Units with Cables

E3X-SD11
E3X-SD41
E3X-NA11
E3X-NA11F
E3X-NA41
E3X-NA41F

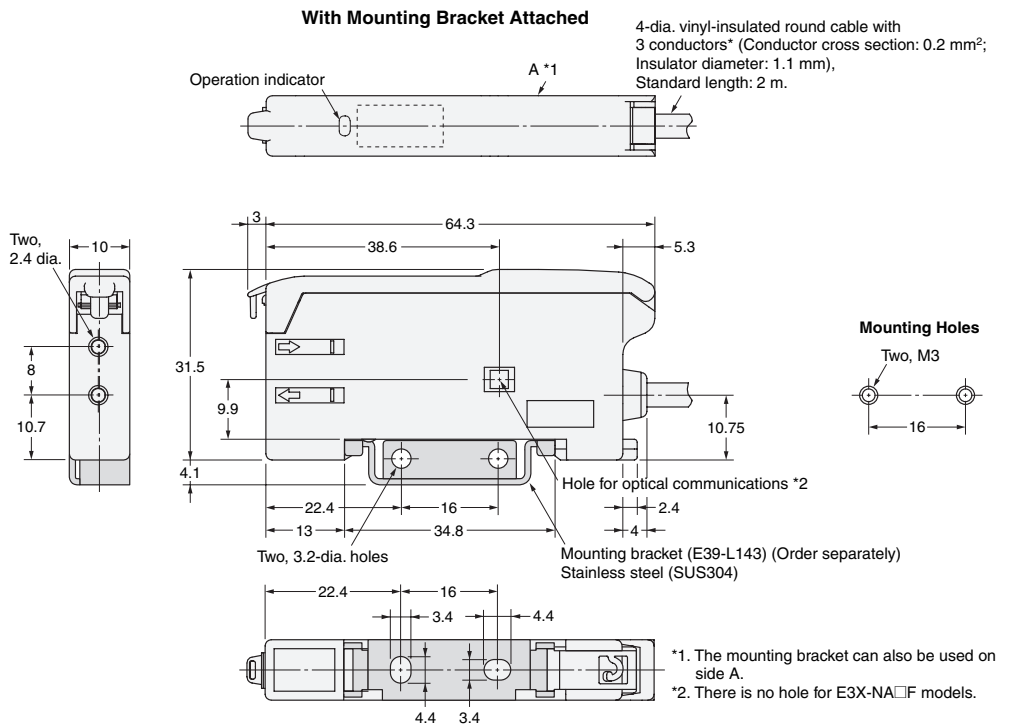

Amplifier Units with Connectors

E3X-SD6
E3X-SD8
E3X-NA6
E3X-NA8

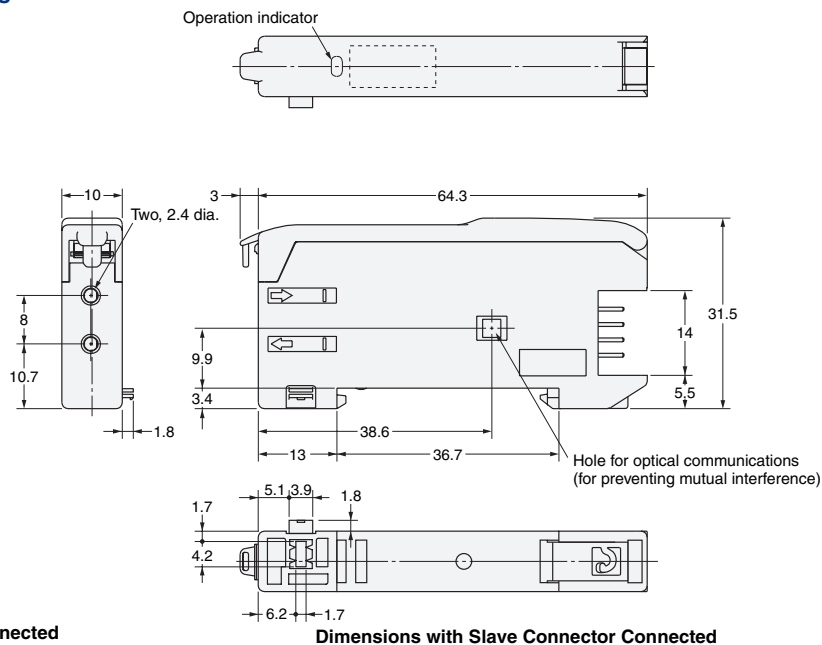

Dimensions with Master Connector Connected

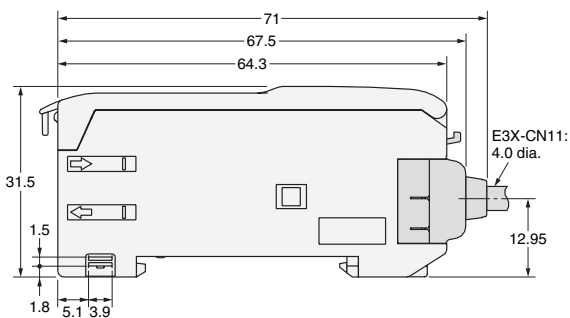

Dimensions with Slave Connector Connected

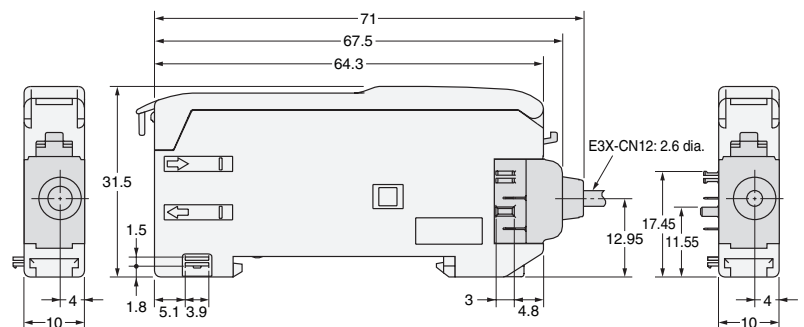

E3X-SD/-NA

Amplifier Units with Cables, Water-resistant Models E3X-NA11V E3X-NA41V

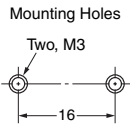
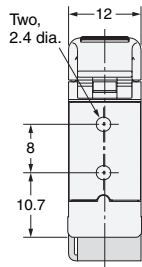
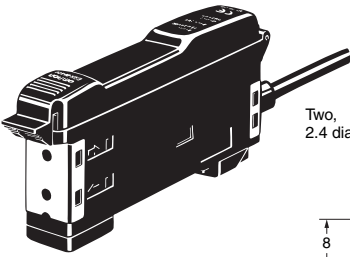

With Mounting Bracket Attached

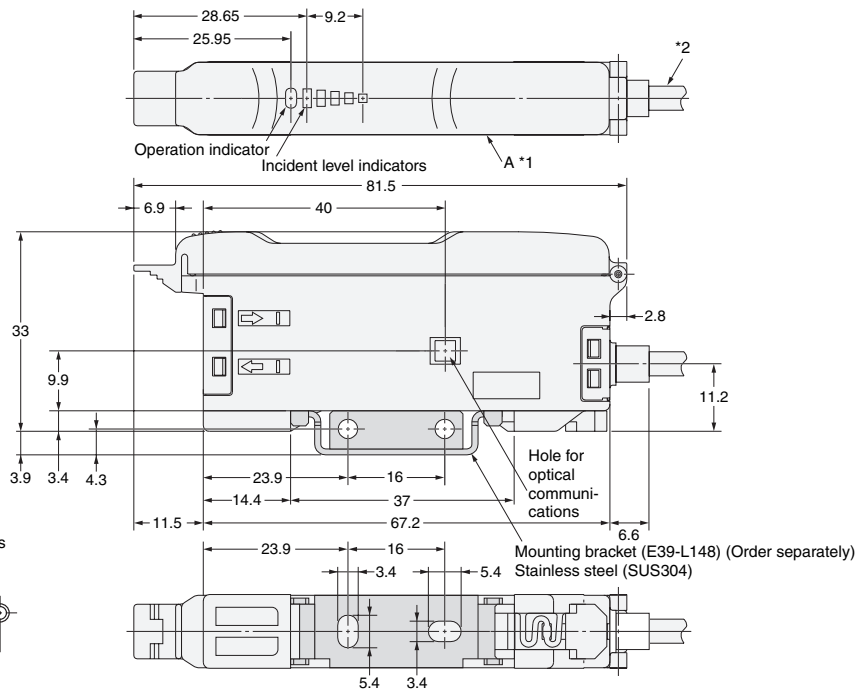

- *1. The mounting bracket can also be used on side A.
- *2. 4-dia. vinyl-insulated round cable with 3 conductors (Conductor cross section: 0.45 mm², Insulator diameter: 1.1 mm), Standard length: 2 m.

Amplifier Units with Connectors, Water-resistant Models E3X-NA14V E3X-NA44V

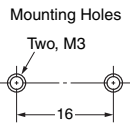
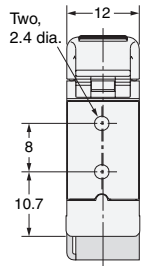
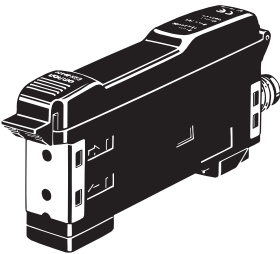

* The mounting bracket can also be used on this side A.

With Mounting Bracket Attached

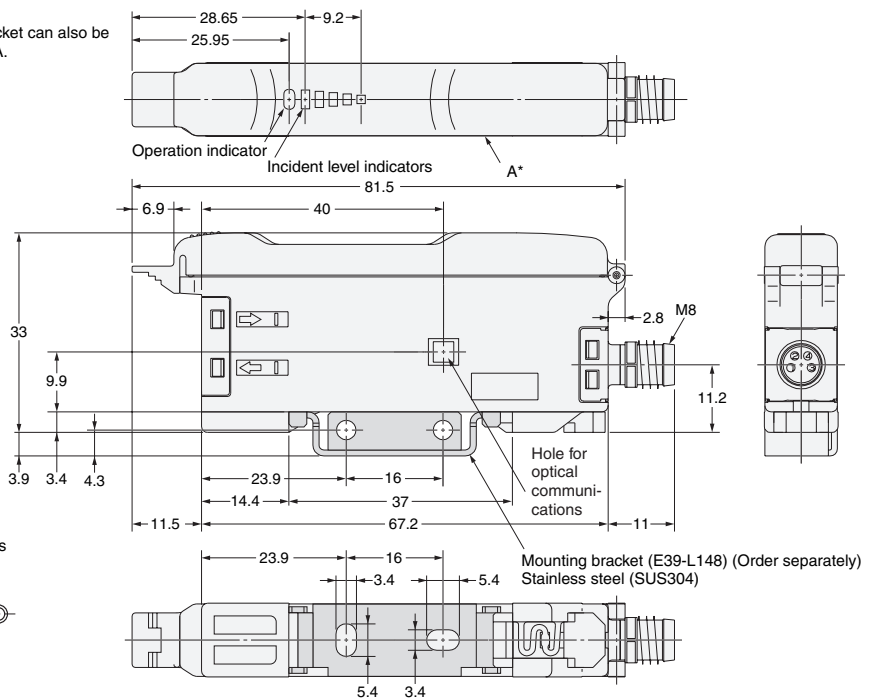

Amplifier Unit Connectors

Master Connector E3X-CN11

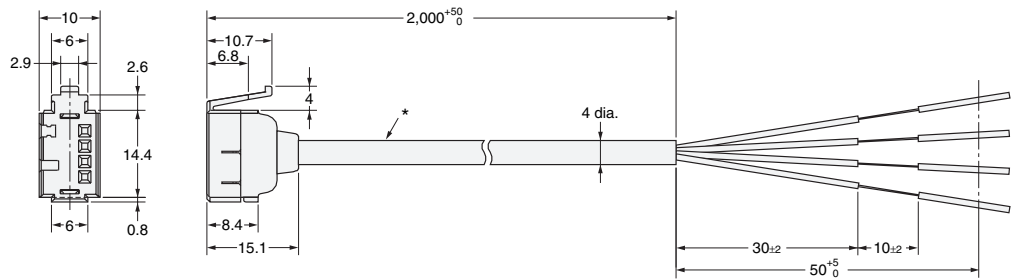
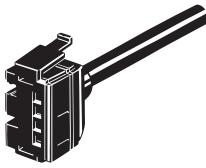

*E3X-CN11: 2.6-dia. vinyl-insulated round cable with 3 conductors (Conductor cross section: 0.2 mm², Insulator diameter: 1.1 mm)

Slave Connector E3X-CN12

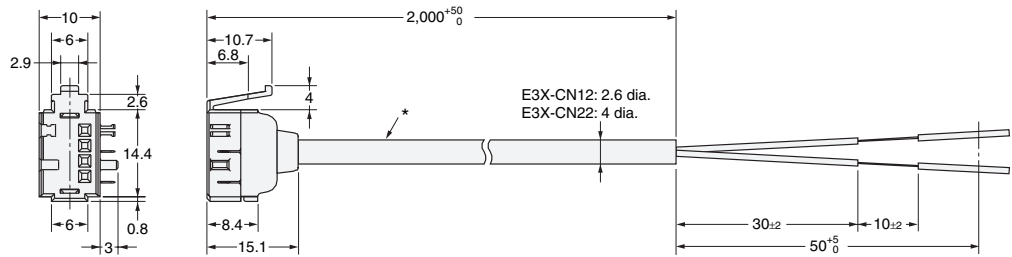
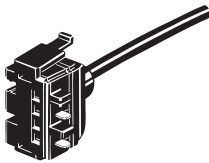

*E3X-CN12: 2.6-dia. vinyl-insulated round cable with 1 conductor (Conductor cross section: 0.2 mm², Insulator diameter: 1.1 mm)

Accessories (Order Separately)

Mounting Brackets E39-L143

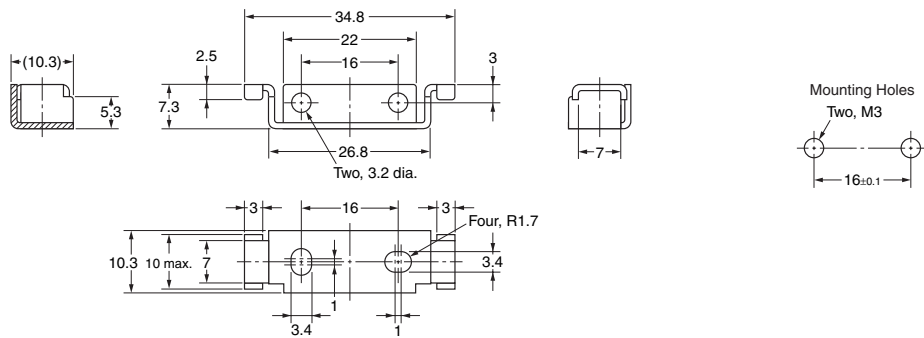
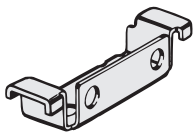

Material: Stainless steel (SUS304)

End Plates PFP-M

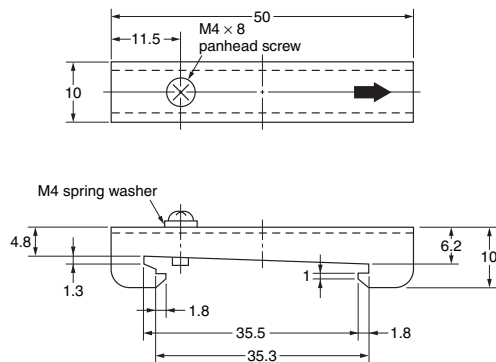
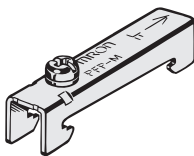

For information on Fiber Units, refer to the *E32 Series Fiber Sensor Best Selection* (Cat. No. E354).



E3X-SD/-NA

Operating Procedure

E3X-SD□

1 Displays

A 7-segment display showing excess gain is provided in addition to the orange operation indicator. Use these when adjusting the light axis and setting the sensitivity at setup.

Display/indicator status (for L/ON)	Excess gain	Description
	999% (10 times)	110% min. Stable incident light
	100%	90% to 110% Unstable incident light or Unstable interrupted light
	0%	90% max. Stable interrupted light

2 Sensitivity Setting

The sensitivity can be set with the UP and DOWN Keys similar to using an adjuster knob. The sensitivity can also be easily set by using the following three teaching functions.

2-1. Maximum Sensitivity Setting

The sensitivity can be set to the maximum. This is the optimal setting for resistance against the effects of dust.

Operation description	Switch/Key	Display
Set the TEACH/RUN selector switch to TEACH.	TEACH RUN [TEACH]	0 t E c h ◀▶ 0 103P
Press the UP Key for 3 s min.	UP [UP]	0 FULL
Set the TEACH/RUN selector switch to RUN (start of measurement).	TEACH RUN [RUN]	0 r u n ▶ 0 103P

2-2. Teaching with/without a Workpiece

Two points (one with the workpiece and the other without) are detected, and the operating level is set to the midpoint.

Operation description	Switch/Key	Display
Set the TEACH/RUN selector switch to TEACH.	TEACH RUN [TEACH]	0 t E c h ◀▶ 0 103P
Press the UP Key with the workpiece present.	UP [UP]	0 - - - -
Press the UP Key with the workpiece not present.	UP [UP]	0 2 P n t
Set the TEACH/RUN selector switch to RUN (start of measurement).	TEACH RUN [RUN]	0 r u n ▶ 0 103P

2-3. Automatic Teaching

Changes within a time are detected, and the operating level is set to the midpoint between the maximum and the minimum values of the changes. This setting is optimal for when the workpieces cannot be stopped.





Operation description	Switch/Key	Display
Set the TEACH/RUN selector switch to TEACH.	TEACH RUN [TEACH]	0 t E c h ◀▶ 0 103P
Press the UP Key.	UP [UP]	0 - - - -

Operation description	Switch/Key	Display
Hold down the UP Key during detection. Let the workpiece pass while the key is held down.	UP [UP]	0 R U t e
Set the TEACH/RUN selector switch to RUN (start of measurement).	TEACH RUN [RUN]	0 r u n ▶ 0 103P

E3X-NA□

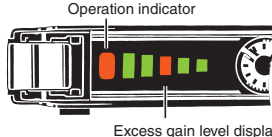
1 Displays

A bar display (with four green and one red) showing excess gain is provided in addition to the orange operation indicator. Use these when adjusting the light axis and setting the sensitivity at setup.

Display/indicator status (for L/ON)	Excess gain level	Description
	Approx. 120% min.	Stable incident light
	Approx. 110% to 120%	
	Approx. 90% to 110%	Unstable incident light or Unstable interrupted light
	Approx. 80% to 90%	Stable interrupted light
	Approx. 80% max.	

READ AND UNDERSTAND THIS DOCUMENT

Please read and understand this document before using the products. Please consult your OMRON representative if you have any questions or comments.

WARRANTY

OMRON's exclusive warranty is that the products are free from defects in materials and workmanship for a period of one year (or other period if specified) from date of sale by OMRON.

OMRON MAKES NO WARRANTY OR REPRESENTATION, EXPRESS OR IMPLIED, REGARDING NON-INFRINGEMENT, MERCHANTABILITY, OR FITNESS FOR PARTICULAR PURPOSE OF THE PRODUCTS. ANY BUYER OR USER ACKNOWLEDGES THAT THE BUYER OR USER ALONE HAS DETERMINED THAT THE PRODUCTS WILL SUITABLY MEET THE REQUIREMENTS OF THEIR INTENDED USE. OMRON DISCLAIMS ALL OTHER WARRANTIES, EXPRESS OR IMPLIED.

LIMITATIONS OF LIABILITY

OMRON SHALL NOT BE RESPONSIBLE FOR SPECIAL, INDIRECT, OR CONSEQUENTIAL DAMAGES, LOSS OF PROFITS OR COMMERCIAL LOSS IN ANY WAY CONNECTED WITH THE PRODUCTS, WHETHER SUCH CLAIM IS BASED ON CONTRACT, WARRANTY, NEGLIGENCE, OR STRICT LIABILITY.

In no event shall responsibility of OMRON for any act exceed the individual price of the product on which liability is asserted.

IN NO EVENT SHALL OMRON BE RESPONSIBLE FOR WARRANTY, REPAIR, OR OTHER CLAIMS REGARDING THE PRODUCTS UNLESS OMRON'S ANALYSIS CONFIRMS THAT THE PRODUCTS WERE PROPERLY HANDLED, STORED, INSTALLED, AND MAINTAINED AND NOT SUBJECT TO CONTAMINATION, ABUSE, MISUSE, OR INAPPROPRIATE MODIFICATION OR REPAIR.

SUITABILITY FOR USE

THE PRODUCTS CONTAINED IN THIS DOCUMENT ARE NOT SAFETY RATED. THEY ARE NOT DESIGNED OR RATED FOR ENSURING SAFETY OF PERSONS, AND SHOULD NOT BE RELIED UPON AS A SAFETY COMPONENT OR PROTECTIVE DEVICE FOR SUCH PURPOSES. Please refer to separate catalogs for OMRON's safety rated products.

OMRON shall not be responsible for conformity with any standards, codes, or regulations that apply to the combination of products in the customer's application or use of the product.

At the customer's request, OMRON will provide applicable third party certification documents identifying ratings and limitations of use that apply to the products. This information by itself is not sufficient for a complete determination of the suitability of the products in combination with the end product, machine, system, or other application or use.

The following are some examples of applications for which particular attention must be given. This is not intended to be an exhaustive list of all possible uses of the products, nor is it intended to imply that the uses listed may be suitable for the products:

- Outdoor use, uses involving potential chemical contamination or electrical interference, or conditions or uses not described in this document.
- Nuclear energy control systems, combustion systems, railroad systems, aviation systems, medical equipment, amusement machines, vehicles, safety equipment, and installations subject to separate industry or government regulations.
- Systems, machines, and equipment that could present a risk to life or property.

Please know and observe all prohibitions of use applicable to the products.

NEVER USE THE PRODUCTS FOR AN APPLICATION INVOLVING SERIOUS RISK TO LIFE OR PROPERTY WITHOUT ENSURING THAT THE SYSTEM AS A WHOLE HAS BEEN DESIGNED TO ADDRESS THE RISKS, AND THAT THE OMRON PRODUCT IS PROPERLY RATED AND INSTALLED FOR THE INTENDED USE WITHIN THE OVERALL EQUIPMENT OR SYSTEM.

PERFORMANCE DATA

Performance data given in this document is provided as a guide for the user in determining suitability and does not constitute a warranty. It may represent the result of OMRON's test conditions, and the users must correlate it to actual application requirements. Actual performance is subject to the OMRON Warranty and Limitations of Liability.

CHANGE IN SPECIFICATIONS

Product specifications and accessories may be changed at any time based on improvements and other reasons.

It is our practice to change model numbers when published ratings or features are changed, or when significant construction changes are made. However, some specifications of the product may be changed without any notice. When in doubt, special model numbers may be assigned to fix or establish key specifications for your application on your request. Please consult with your OMRON representative at any time to confirm actual specifications of purchased products.

DIMENSIONS AND WEIGHTS

Dimensions and weights are nominal and are not to be used for manufacturing purposes, even when tolerances are shown.

ERRORS AND OMISSIONS

The information in this document has been carefully checked and is believed to be accurate; however, no responsibility is assumed for clerical, typographical, or proofreading errors, or omissions.

PROGRAMMABLE PRODUCTS

OMRON shall not be responsible for the user's programming of a programmable product, or any consequence thereof.

COPYRIGHT AND COPY PERMISSION

This document shall not be copied for sales or promotions without permission.

This document is protected by copyright and is intended solely for use in conjunction with the product. Please notify us before copying or reproducing this document in any manner, for any other purpose. If copying or transmitting this document to another, please copy or transmit it in its entirety.

This document provides information mainly for selecting suitable models. Please read the Instruction sheet carefully for information that the user must understand and accept before purchase, including information on warranty, limitations of liability, and precautions.

OMRON Corporation
Industrial Automation Company

Sensing Devices Division H.Q.
Industrial Sensors Division
Shiokoji Horikawa, Shimogyo-ku,
Kyoto, 600-8530 Japan
Tel: (81)75-344-7022/Fax: (81)75-344-7107

Regional Headquarters

OMRON EUROPE B.V.
Sensor Business Unit,
Carl-Benz-Str. 4 D-71154 Nufringen,
Germany
Tel: (49) 7032-811-0/Fax: (49) 7032-811-199

OMRON ELECTRONICS LLC
One Commerce Drive Schaumburg,
IL 60173-5302 U.S.A.
Tel: (1) 847-843-7900/Fax: (1) 847-843-7787

OMRON ASIA PACIFIC PTE. LTD.
No. 438A Alexandra Road # 05-05/08 (Lobby 2),
Alexandra Technopark, Singapore 119967
Tel: (65) 6835-3011/Fax: (65) 6835-2711
83 Clemenceau Avenue,

OMRON (CHINA) CO., LTD.
Room 2211, Bank of China Tower,
200 Yin Cheng Zhong Road,
Pu Dong New Area, Shanghai, 200120, China
Tel: (86) 21-5037-2222/Fax: (86) 21-5037-2200

Authorized Distributor:

Note: Specifications subject to change without notice. Cat. No. E388-E1-01