

Ø 4 mm-Abgreifer
Starre Hakenlemmen

SKPS-4/A



Abgreifer mit starrer Hakenklemme aus Stahl zum Anhängen an Drähte. 360° drehbar um die Längsachse des Abgreifers. Starre Ø 4 mm-Buchse im Griffteil, geeignet zur Aufnahme federnder Ø 4 mm-Stecker mit starrer Isolierhülse.

Ø 4 mm Test Clips
Rigid Hook Clips

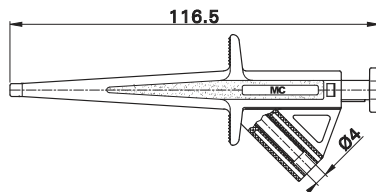

Test connector with rigid hook clip made of steel for hooking onto wires. Rotatable through 360° around the longitudinal axis of the test probe. Ø 4 mm rigid socket in handle accepting spring-loaded Ø 4 mm plugs with rigid insulating sleeve.

Pinces Ø 4 mm
Crochets rigides

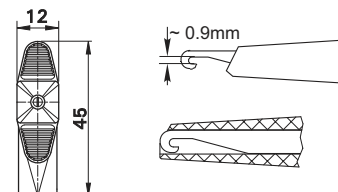

Grippe-fils à crochet rigide en acier permettant de saisir des fils. Tournant sur 360° autour de l'axe longitudinal du grippe-fils. Equipé, dans la zone de préhension d'une douille rigide Ø 4 mm, adaptée à la connexion de fiches Ø 4 mm élastiques à fourreau rigide.

Typ Type Type	Best.-Nr. Order No. N° de Cde	Bemessungsspannung / -strom Rated voltage / current Tension / intensité assignée		*Farben *Colours *Couleurs
---------------------	-------------------------------------	--	--	----------------------------------

SKPS-4/A

66.9416-*

1000 V, CAT III / max. 4 A

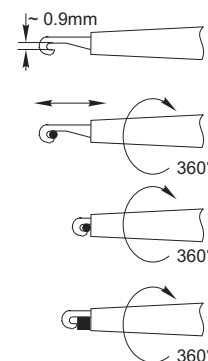
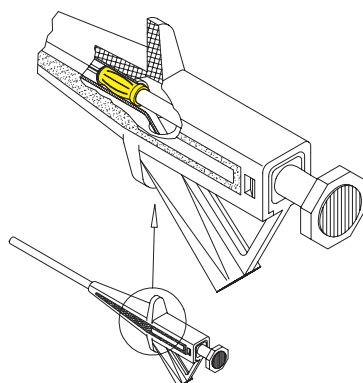
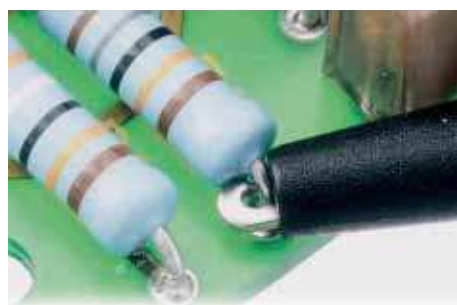

Zuverlässige Spannungs- und Stromübertragung sowie geringer Übergangswiderstand durch den Einsatz unserer bewährten Kontaktlamelle im SKPS-4.

Reliable voltage and current transmission and low contact resistance due to the use of our proven Multilam™.

L'utilisation de nos contacts à lamelles éprouvés dans le modèle SKPS-4 garantit un contact électrique fiable et une faible résistance de passage.

Ø 4 mm-Abgreifer
Krokodilklemmen

AGK20



Unisolierte Abgreifklemme mit starrer Ø 4 mm-Buchse. Stahl. Anschluss auch möglich über Klemmschraube oder Lötanschluss.

Ø 4 mm Test Clips
Crocodile Clips

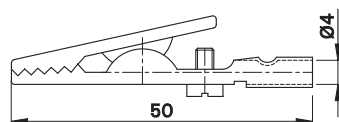

Uninsulated test clip with Ø 4 mm rigid socket. Steel. Connection also possible with screw clamp or soldering.

Pinces Ø 4 mm
Pinces crocodiles

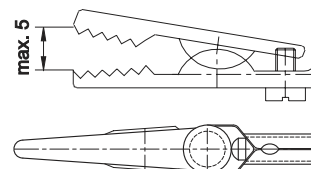

Pince crocodile non-isolée, équipée d'une douille rigide Ø 4 mm. Acier. Raccordement également possible par vis de pression ou par soudure.

Typ Type Type	Best.-Nr. Order No. N° de Cde	Bemessungsspannung / -strom Rated voltage / current Tension / intensité assignée		*Farben *Colours *Couleurs
---------------------	-------------------------------------	--	--	----------------------------------

AGK20

24.0149

30 V_{AC} ~ 60 V_{DC} / max. 10 A

