



USB Controlled DMX interface

Control DMX fixtures using a PC and USB interface.
Stand-alone test function that outputs all 512 channels at a time, with adjustable levels.

Total solder points: 117

Difficulty level: *beginner* 1 2 3 4 5 *advanced*

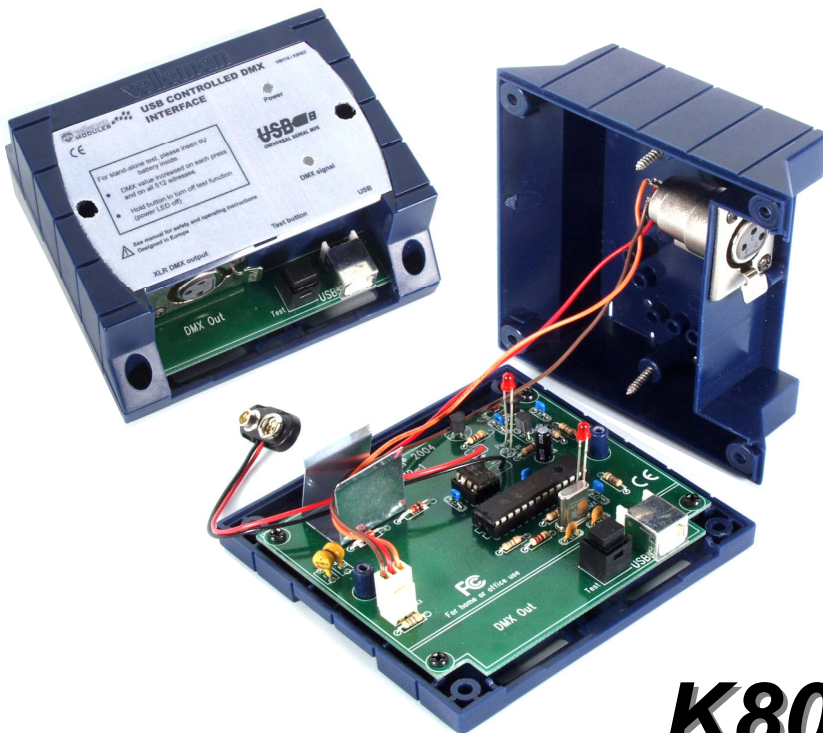

K8062

Features :

- ☑ This unit can control DMX fixtures using a PC and USB interface
- ☑ Test software and "DMX Light Player" software is included, a DLL is provided to write you own software
- ☑ Furthermore there is a stand-alone test function that outputs all 512 channels at a time, with adjustable levels

Specifications :

- Connected and powered through USB
- 512 DMX channels with 256 levels each
- 3 pin XLR[Ⓒ] DMX output connector
- Windows 98SE or higher compatible
- DLL included to write your own software
- Optional 9V battery needed for stand alone test mode
- Solid state - fuse protection on DMX output
- Dimensions: 106 x 101 x 44.5mm (4.2" x 4.0" x 1.75")

*If a DMX terminator is used, you will also need a USB hub (e.g. our PCUSB3)

Kit includes:

- Enclosure
- USB cable
- CD with: test software, DLL for own developments, free DMX light player*

* If not included, check our website <http://www.velleman.be>

This device complies with Part 15 of the FCC Rules provided the enclosed instructions are followed to the letter. Use of the device is subject to the following conditions: (1) this device must not cause harmful interference and (2) the operation of this device should not be influenced by unwanted interference.

More information about FCC can be look at <http://www.fcc.gov>



1. Assembly (Skipping this can lead to troubles !)

Ok, so we have your attention. These hints will help you to make this project successful. Read them carefully.

1.1 Make sure you have the right tools:

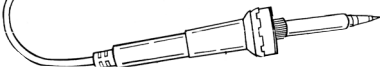
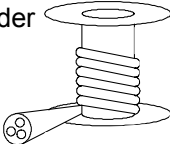
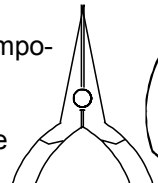
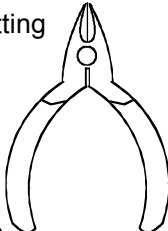
- A good quality soldering iron (25-40W) with a small tip. 
- Wipe it often on a wet sponge or cloth, to keep it clean; then apply solder to the tip, to give it a wet look. This is called **thinning** and will protect the tip, and enables you to make good connections. When solder rolls off the tip, it needs cleaning.
- Thin raisin-core solder. Do not use any flux or grease. 
- A diagonal cutter to trim excess wires. To avoid injury when cutting excess leads, hold the lead so they cannot fly towards the eyes.
- Needle nose pliers, for bending leads, or to hold components in place. 
- Small blade and Phillips screwdrivers. A basic range is fine. 

 **For some projects, a basic multi-meter is required, or might be handy**

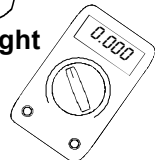

1.2 Assembly Hints :

- ⇒ Make sure the skill level matches your experience, to avoid disappointments.
- ⇒ Follow the instructions carefully. Read and understand the entire step before you perform each operation.
- ⇒ Perform the assembly in the correct order as stated in this manual
- ⇒ Position all parts on the PCB (Printed Circuit Board) as shown on the drawings.
- ⇒ Values on the circuit diagram are subject to changes.
- ⇒ Values in this assembly guide are correct*

- ⇒ Use the check-boxes to mark your progress.
- ⇒ Please read the included information on safety and customer service

* Typographical inaccuracies excluded. Always look for possible last minute manual updates, indicated as NOTE on a separate leaflet.

1.3 Soldering Hints :

1- Mount the component against the PCB surface and carefully solder the leads

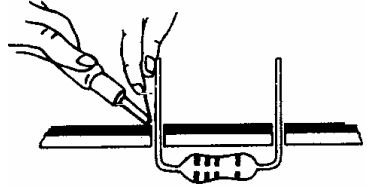

2- Make sure the solder joints are cone-shaped and shiny

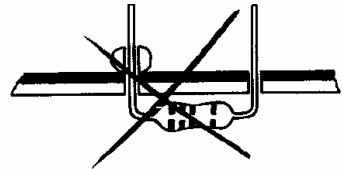
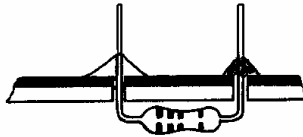

3- Trim excess leads as close as possible to the solder joint

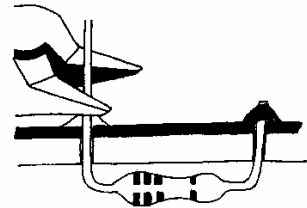

AXIAL COMPONENTS ARE TAPED IN THE CORRECT MOUNTING SEQUENCE !

REMOVE THEM FROM THE TAPE ONE AT A TIME !

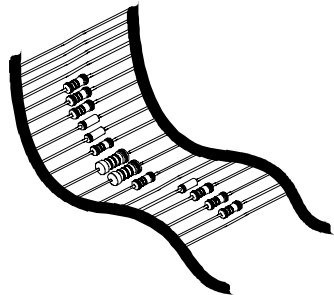

 You will find the colour code for the resistances on our website: <http://www.velleman.be/common/service.aspx>

1. Diode (check the polarity)

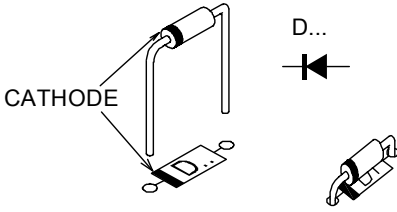

- D1 : 1N4148

2. Zener diodes (check the polarity)

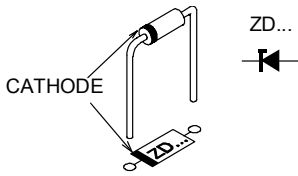

- ZD1 : 6,2V (6V2)
- ZD2 : 6,2V (6V2)

3. 1/4W Resistors.

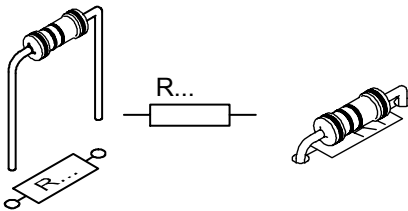

- R1 : 10K (1 - 0 - 3 - B)
- R2 : 10K (1 - 0 - 3 - B)
- R3 : 1K5 (1 - 5 - 2 - B)
- R4 : 470 (4 - 7 - 1 - B)
- R5 : 1K5 (1 - 5 - 2 - B)
- R6 : 1K5 (1 - 5 - 2 - B)
- R7 : 2K2 (2 - 2 - 2 - B)
- R8 : 470 (4 - 7 - 1 - B)

R9 will not be mounted

4. IC sockets

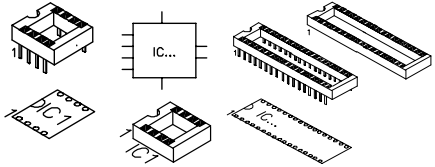

- IC1 : 8P
- IC2 : 28P

5. Capacitors

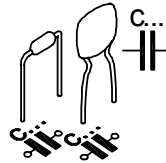

- C1 : 33pF (33)
- C2 : 33pF (33)
- C3 : 100n (104, 0.1, u1)
- C4 : 100n (104, 0.1, u1)
- C5 : 100n (104, 0.1, u1)
- C6 : 100n (104, 0.1, u1)
- C7 : 220n (224)

6. Transistors

- T1 : BC327
- T2 : BC337

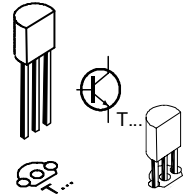

7. Voltage regulator.

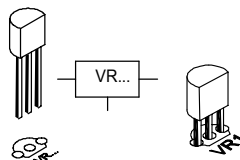

- VR1: UA78L05

8. USB connector

- SK4 : USBB90

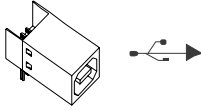

9. Polyswitch resettable fuses

- FS1 : 3A /60Vdc
- FS2 : 3A/60Vdc

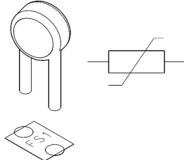

The PTC resistor resets automatically and protects your circuit permanently.

10. Electrolytic capacitor. Check the polarity !

- C8 : 4,7 μ F

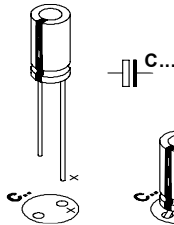

11. Header

- SK3 : 3P

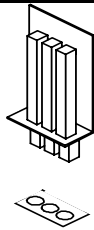

12. Quartz crystal

- X1 : 4MHz

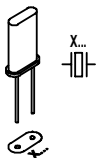

13. Push button *

- SW1

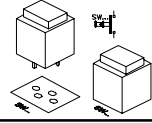

14. Battery holder *

4mm M3 BOLT

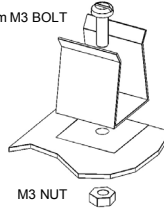

Mount the battery clip on the PCB using the 4mm M3 bolt and M3 nut.

M3 NUT

15. LEDs. Check the polarity!

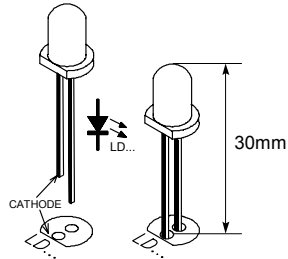

- LD1 : 3mm RED Power ON \bar{A}
- LD2 : 3mm RED DMX \bar{A}

16. Battery snap *

- SK1 : + (Red)
- S2 : - (Black)

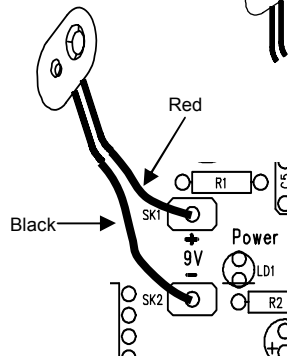
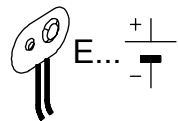

* **Note** : If stand alone function is not used, do not mount these parts.

17. IC s check the position !

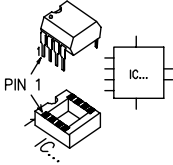

❑ IC1 : SN75176BP or MAX485

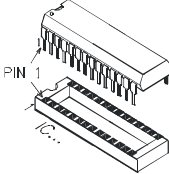

❑ IC2 : VK8062 (programmed PIC18F2550)*

18. CE/FCC Sticker

Affix the supplied CE/FCC sticker on the bottom of the housing, see fig. 1.0.

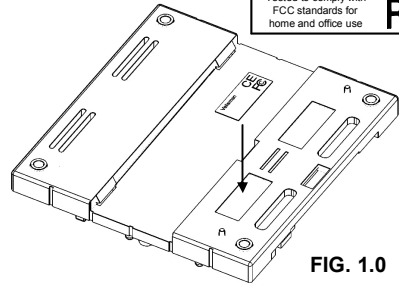
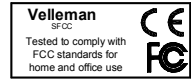

19. XLR socket.

Solder the 3-pole female print connector to the XLR connector using the figure below to check the accuracy of the connections (see fig. 2.0 & 3.0).

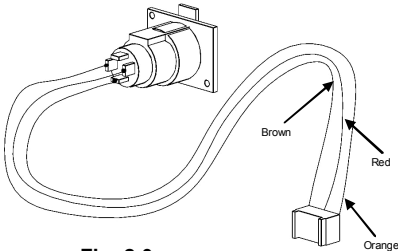

Fig. 2.0

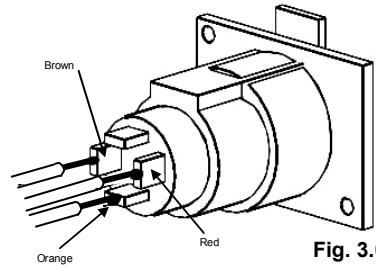

Fig. 3.0

Now mount the female 3-pole XLR connector in the provided opening in the upper part of the housing, securing it with the included selftapping screws (flat head 2.9 x 6.5mm), see figure 4.0.

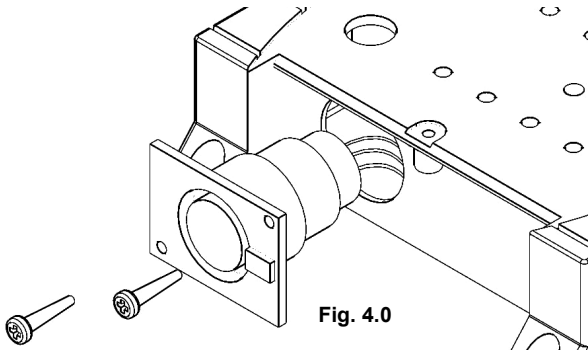

Fig. 4.0

* firmware rev. 3 or higher

20. Assembly

- Fix the PCB using 4 screws (2.9 x 6,5mm).
- Connect the wired connector to 3p header (SK3).
- If stand alone function is used, connect the battery to the connector and insert the battery in the battery compartment as indicated in fig. 5.0.
- Close the enclosure with the longest supplied screws (2.9 x 9.5mm).
- Affix the supplied front sticker on the top of the enclosure.

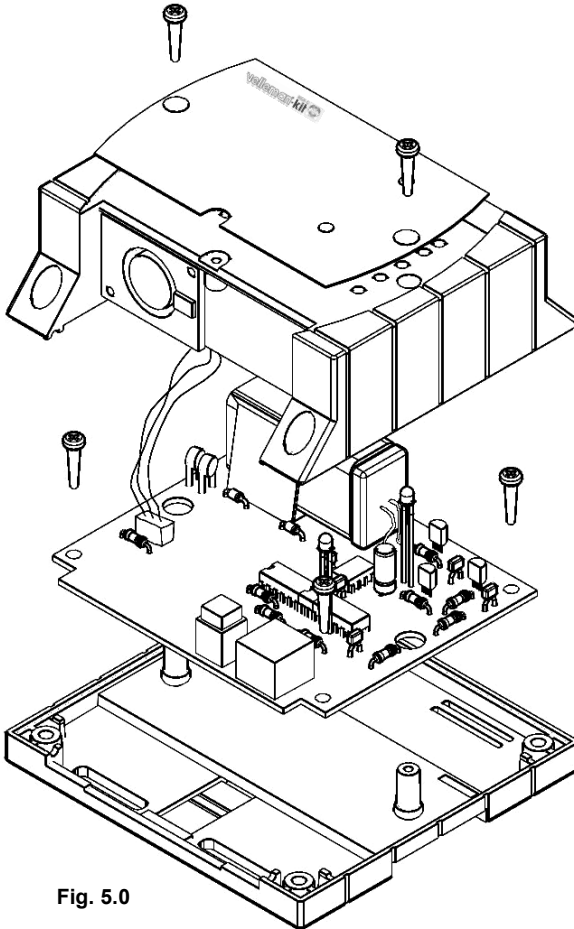

Fig. 5.0



Remark : Respect your national and local laws when disposing of empty batteries.

21. Software installation

- Browse through the CD and open the K8062 folder.
- Check the appropriate PDF files for further information.

The light player software is installed in the folder by default: c:\program files\DMX

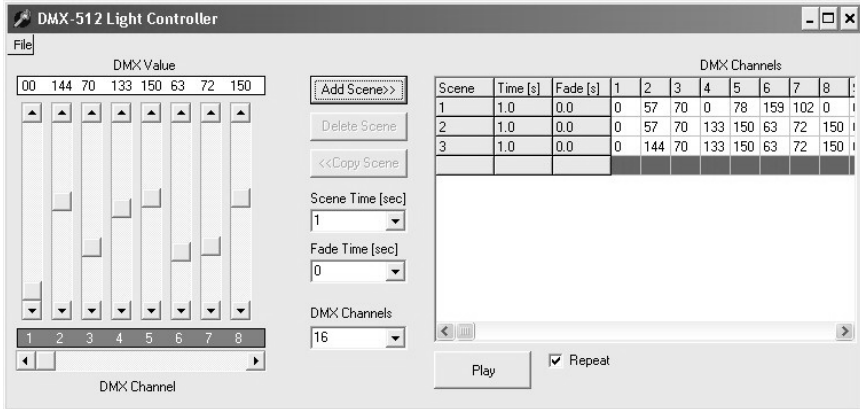

This is a screen shot of the DMX_demo software, used to test the unit or to make some simple shows.

You will find the latest version of the software on our website

22. Stand alone test mode

For the stand alone DMX test mode a 9V battery must be connected between the connectors SK1 (+) and SK2 (-).

Test button SW1 is used to control the operation of the test mode.

Operation :

- Do not connect the unit to the USB cable.
- A short button press turns the unit on. - Power LED goes on and the unit starts to send DMX code "0" on all the 512 DMX channels.
- Next button press increments the code on all the channels to '1', next button press increments to '2' etc.
- The "DMX signal" LED starts to light periodically when the test button is pressed for some times.
- The LED's flashes are longer after pressing the button for several times.
- Pressing the button 256 times the internal counter rolls back to 0 and the unit starts again to send code "0" on all the 512 DMX channels.
- If you use e.g. a dimmer as a test equipment you should see how the intensity of the light increases on every button press.
- To turn the power off, keep pressing the button about 3 seconds until the power LED goes off.

23. PCB

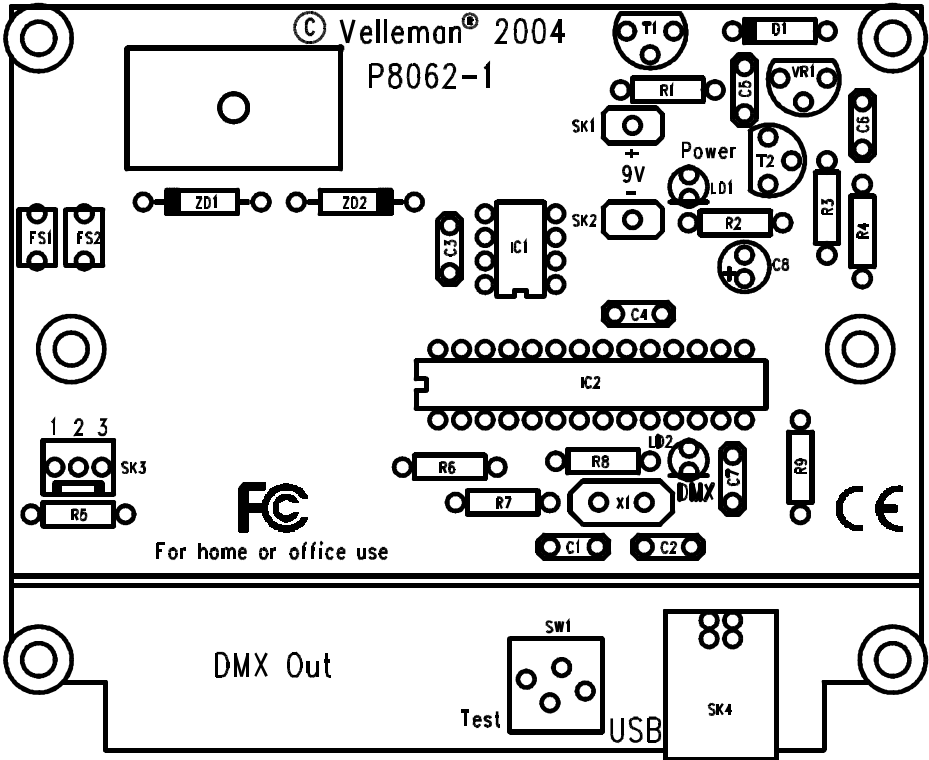

24. Diagram

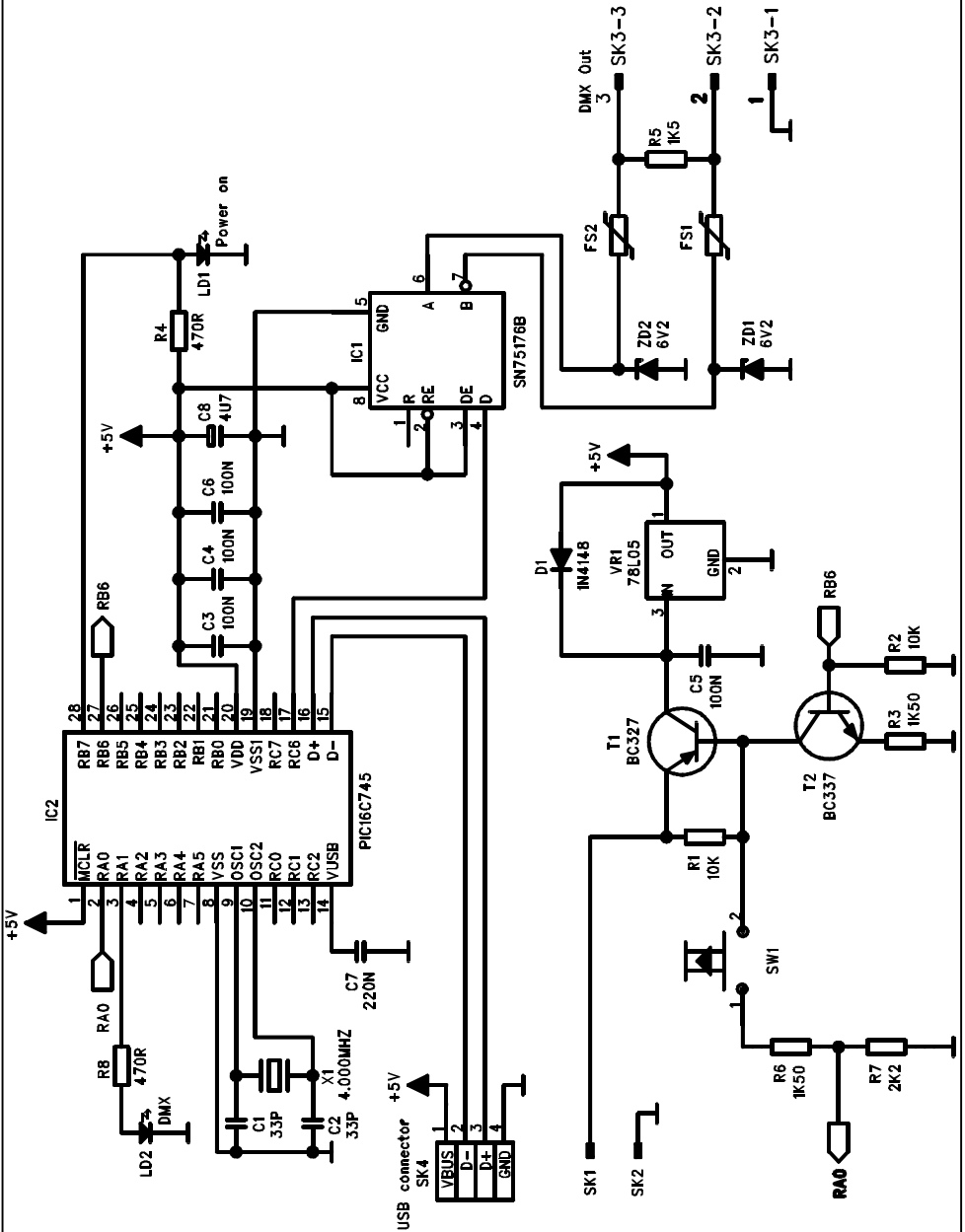



VELLEMAN KIT NV
Legen Heirweg 33
9890 Gavere
Belgium Europe
Info ? : <http://www.velleman.be>

Modifications and typographical errors reserved
÷ Velleman Kit nv
H8062IP - 2007 - ED1 (rev 3.0)

