







# PA257 – 5.08

Header terminal block



## TECHNICAL DATA

	IEC	UL / CSA	
<b>Pitch</b>	5.08 mm	0.2"	
<b>Poles</b>	2 + 24		
<b>Versions</b>	VE/A vertical open - VE/C vertical closed - HO/A horizontal open - HO/C horizontal closed		
<b>Ratings</b>	450V - 10A	300V - 15A	
<b>Wire size</b>	n.a.	n.a.	
<b>Working Temperature</b>	-5 ÷ 85 °C (short time 115 °C)	23 + 284 °F	
<b>Plastic Material</b>	Green Polyamide PA6.8, UL94-V0, CTI600V, GWT960 °C		
<b>Metal Parts</b>	Soldering pin made in tin plated brass		
<b>Screw Torque</b>	n.a.	n.a.	
<b>Accessories</b>	PA257 C / CAR-IND		
Approvals	File Nr.	Ratings (sqmm/AWG – V – A – T)	Standard References
	E 9396	450V - 10A - 85 °C	EN60998-1; EN60998-2-1
	122258 ÜG	400V - 10A - -5 ÷ 125 °C	DIN VDE 0627:1991-09
	E76048 vol. 1 sec. 7	300V - 15A - 140 °C	UL1059
	LR40455	300V - 15A	CSA C22-2 N.158-1987; E.C.N 584B

DIMENSIONAL  
DRAWING

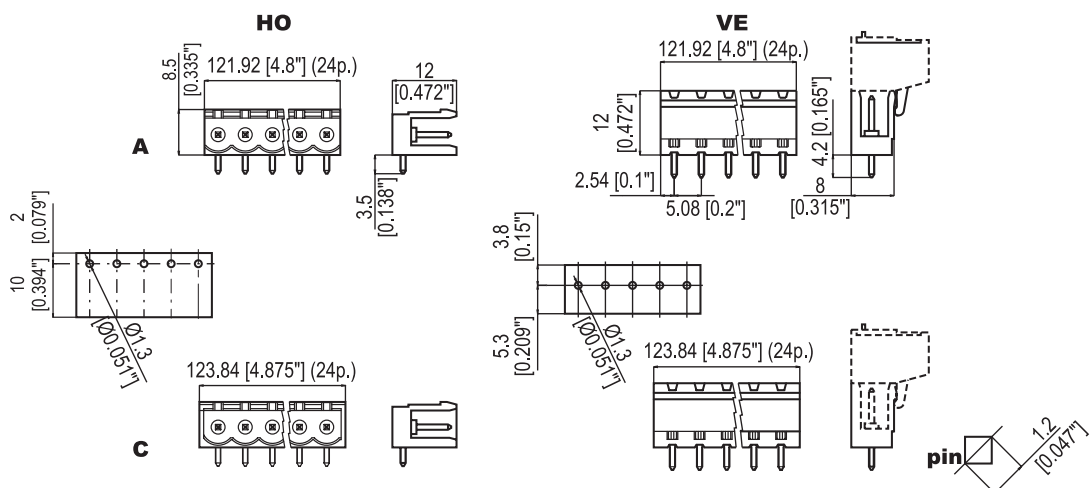



# PA257 – 5.08

## ACCESSORIES

### PA 257 C

Polarisation key used on the terminal block system PA 257 in order to avoid incorrect connections, without losing poles, of the female holder PA257 fitted with the polarisation key PA256; supplied in rows of key PA256 C; supplied in rows of 21 pieces.



### CAR-IND

Self adhesive label of ten symbols.  
Package of 10 sheets each with 25 labels.

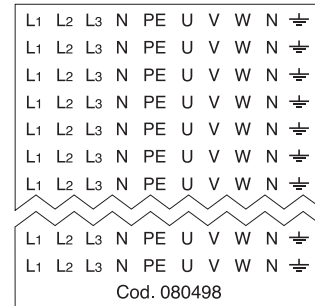
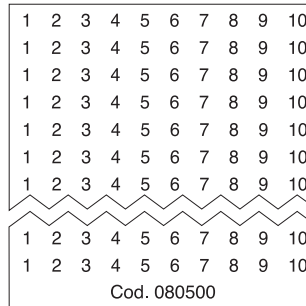

## PACKAGING

Type	P-N:	VE/A	VE/C	HO/A	HO/C	Pack
PA 257/5.08/2		00119582	00119642	00119552	00119612	100
PA 257/5.08/3		00119583	00119643	00119553	00119613	100
PA 257/5.08/4		00119584	00119644	00119554	00119614	100
PA 257/5.08/5		00119585	00119645	00119555	00119615	100
PA 257/5.08/6		00119586	00119646	00119556	00119616	100
PA 257/5.08/7		00119587	00119647	00119557	00119617	100
PA 257/5.08/8		00119588	00119648	00119558	00119618	50
PA 257/5.08/9		00119589	00119649	00119559	00119619	50
PA 257/5.08/10		00119590	00119650	00119560	00119620	50
PA 257/5.08/11		00119591	00119651	00119561	00119621	50
PA 257/5.08/12		00119592	00119652	00119562	00119622	50
PA 257/5.08/13		00119593	00119653	00119563	00119623	50
PA 257/5.08/14		00119594	00119654	00119564	00119624	50
PA 257/5.08/15		00119595	00119655	00119565	00119625	50
PA 257/5.08/16		00119596	00119656	00119566	00119626	50
PA 257/5.08/17		00119597	00119657	00119567	00119627	50
PA 257/5.08/18		00119598	00119658	00119568	00119628	50
PA 257/5.08/19		00119599	00119659	00119569	00119629	50
PA 257/5.08/20		00119600	00119660	00119570	00119630	50
PA 257/5.08/21		00119601	00119661	00119571	00119631	50
PA 257/5.08/22		00119602	00119662	00119572	00119632	50
PA 257/5.08/23		00119603	00119663	00119573	00119633	50
PA 257/5.08/24		00119604	00119664	00119574	00119634	50

<b>PA 257 C</b>	00971437	50
-----------------	----------	----





# PA257 – 5.08

CAR-IND		
Type	P-N	Pack
L1, L2, L3, N, PE, U, V, W, N,	00080498	250
Neutral	00080499	250
1+ 10	00080500	250
11+ 20	00080501	250
21+ 30	00080502	250
31+ 40	00080503	250
41+ 50	00080504	250
51+ 60	00080505	250
61+ 70	00080506	250
71+ 80	00080507	250
81+ 190	00080508	250
91+ 100	00080509	250

PALLETS	
Europallets	







# PA257 – 10.16

## ACCESSORIES

### PA 257 C

Polarisation key used on the terminal block system PA 257 in order to avoid incorrect connections, without loosening poles, of the female holder PA257 fitted with the polarisation key PA256; supplied in rows of key PA256 C; supplied in rows of 21 pieces.



### CAR-IND

Self adhesive label of ten symbols.  
Package of 10 sheets each with 25 labels.

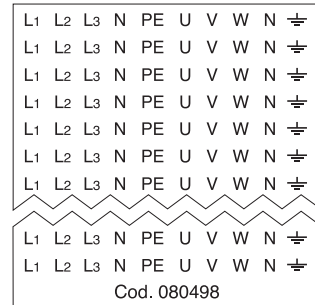
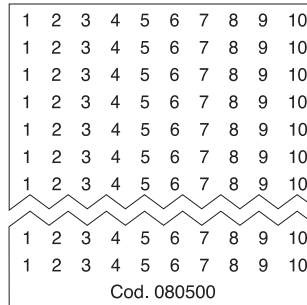

## PACKAGING

Type	P-N:	VE/A	VE/C	HO/A	HO/C	Pack
PA 257/10.16/2		00119692	00119732	00119672	00119712	100
PA 257/10.16/3		00119693	00119733	00119673	00119713	100
PA 257/10.16/4		00119694	00119734	00119674	00119714	100
PA 257/10.16/5		00119695	00119735	00119675	00119715	50
PA 257/10.16/6		00119696	00119736	00119676	00119716	50
PA 257/10.16/7		00119697	00119737	00119677	00119717	50
PA 257/10.16/8		00119698	00119738	00119678	00119718	50
PA 257/10.16/9		00119699	00119739	00119679	00119719	50
PA 257/10.16/10		00119700	00119740	00119680	00119720	50
PA 257/10.16/11		00119701	00119741	00119681	00119721	50
PA 257/10.16/12		00119702	00119742	00119682	00119722	50

PA 257 C	00971437	50
----------	----------	----

## CAR-IND

Type	P-N	Pack
L1, L2, L3, N, PE, U, V, W, N, Neutral	00080498	250
	00080499	250
1+ 10	00080500	250
11+ 20	00080501	250
21+ 30	00080502	250
31+ 40	00080503	250
41+ 50	00080504	250
51+ 60	00080505	250
61+ 70	00080506	250
71+ 80	00080507	250
81+ 190	00080508	250
91+ 100	00080509	250

## PALLETS

Europallets

