

## Photoelectric Sensor E3JM

### Photoelectric Sensor with Built-in Power Supply and Wiring Terminal Block for Easy Maintenance and Reliable Operation

- Available for both AC and DC, with self-contained timer function
- Easy-to-wire with stepped terminal block system
- Provides polarized beam for reliable detection of shiny object (Retro-reflective Models)
- Relay output and transistor output models (contact output: SPDT)

#### <READ AND UNDERSTAND THIS CATALOG>

Please read and understand this catalog before purchasing the products. Please consult your OMRON representative if you have any questions or comments.

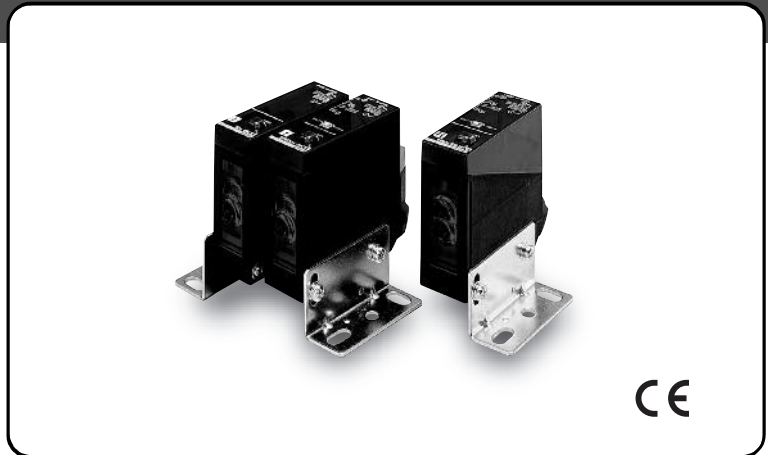

## Ordering Information

### ■ List of Models

When placing your order, specify the conduit type by adding one of the following suffix codes to the model number as shown below.

-G: PG13.5 (European type)

-US: 1/2-14NPT

Sensing method			Through-beam Models	Retro-reflective Models (with MSR function)	Diffuse-reflective Models
Sensing distance			10 m	4 m	700 mm
With timer	Relay output		E3JM-10M4T	E3JM-R4M4T	E3JM-DS70M4T
	DC SSR output	Minus common	E3JM-10S4T	E3JM-R4S4T	E3JM-DS70S4T
		Plus common	E3JM-10R4T	E3JM-R4R4T	E3JM-DS70R4T
Without timer	Relay output		E3JM-10M4	E3JM-R4M4	E3JM-DS70M4
	DC SSR output	Minus common	E3JM-10S4	E3JM-R4S4	E3JM-DS70S4
		Plus common	E3JM-10R4	E3JM-R4R4	E3JM-DS70R4

## ■ Accessories (Order Separately)

### Slit

Slit width	Sensing distance	Minimum sensing object (typical)	Model	Quantity	Remarks
1 mm × 20 mm	1.2 m	1 mm dia.	E39-S39	1 Slit each for Emitter and Receiver (2 Slits total )	(Seal-type long slit) Can be used with the Through-beam Model E3JM-10□4(T).



### Reflectors

Name	Sensing distance (typical)	Model	Quantity	Remarks
Reflectors	4 m (rated value)	E39-R1	1	Provided with the E3JM-R4□4(T).
Small Reflectors	3.5 m	E39-R3	1	---
Tape Reflectors	1 m (200 mm) (See note 2.)	E39-RS1	1	The MSR function is enabled.
	1.6 m (200 mm) (See note 2.)	E39-RS2	1	
	2 m (200 mm) (See note 2.)	E39-RS3	1	

**Note 1.** When the Reflector used is other than the supplied one, set the sensing distance to about 0.7 times of the typical example as a guideline.

**2.** Values in brackets are the minimum required distance between the Sensor and Reflector.

### Mounting Bracket

Appearance	Model	Quantity	Remarks
	E39-L53	1	Provided with the E3JM
	E39-L51	1	Mounting Bracket designed for changing from the E3A-M, E3A2, E3A3, OA-5 or OA-5N to the E3JM.

**Note:** If a Through-beam Model is used, order two Mounting Brackets for the Emitter and Receiver respectively.

# Specifications

## ■ Ratings/Characteristics

Sensing method		Through-beam Model		Retro-reflective Model (with MSR function)		Diffuse-reflective Model	
Item	Model	E3JM-10□4	E3JM-10□4T	E3JM-R4□4	E3JM-R4□4T	E3JM-DS70□4	E3JM-DS70□4T
Sensing distance		10 m		4 m (When using E39-R1)		White paper (200 × 200 mm): 700 mm	
Standard sensing object		Opaque: 14.8-mm dia. min.		Opaque: 75-mm dia.min.		---	
Differential travel		---		---		20% max. of sensing distance	
Directional angle		Both Emitter and Receiver 3° to 20°		1° to 5°		---	
Light source (wavelength)		Infrared LED (950 nm)		Red LED (660 nm)		Infrared LED (950 nm)	
Power supply voltage		12 to 240 VDC±10%, ripple (p-p): 10% max. 24 to 240 VAC±10%, 50/60 Hz					
Power consumption		3 W max.		2 W max.			
Control output		Relay output (M Models): SPDT 250 VAC, 3 A max. (cosφ = 1) 5 VDC, 10 mA min. DC SSR output (S, R Models): 48 VDC, 100 mA max. (residual voltage: 2 V max.) Light-ON/Dark-ON selectable					
Life expectancy	Mechanical	50,000,000 times min. (switching frequency: 18,000 times/h)					
	Electrical	100,000 times min. (switching frequency: 1,800 times/h)					
Response time	Relay output	Operation or reset: 30 ms max.					
	DC SSR output	Operation or reset: 5 ms max.					
Sensitivity adjustment		---				One-turn adjuster	
Timer function (See note.)		ON-delay/OFF-delay/One-shot delay switch selectable Delay time: 0.1 to 5 s (adjustable), only for E3JM-□□□4T					
Ambient illumination (Receiver side)		Incandescent lamp: 3,000 lx max.					
Ambient temperature		Operating: -25°C to 55°C (with no icing or condensation) Storage: -30°C to 70°C (with no icing or condensation)					
Ambient humidity		Operating: 45% to 85% (with no condensation) Storage: 35% to 95% (with no condensation)					
Insulation resistance		20 MΩ min. at 500 VDC between current-carrying parts and case					
Dielectric strength		2,000 VAC, 50/60 Hz for 1 min. between current-carrying parts and case					
Vibration resistance	Destruction	10 to 55 Hz, 1.5-mm double amplitude for 2 hours each in X, Y, and Z directions					
	Malfunction	10 to 55 Hz, 1.5-mm double amplitude for 2 hours each in X, Y, and Z directions					
Shock resistance	Destruction	500 m/s <sup>2</sup> 3 times each in X, Y, and Z directions					
	Malfunction	100 m/s <sup>2</sup> 3 times each in X, Y, and Z directions					
Degree of protection		IEC 60529: IP66					
Connection method		Terminal block					
Indicator		Light indicator (red), power indicator (red)	Operation indicator (red), power indicator (red)	Light indicator (red)	Operation indicator (red)	Light indicator (red)	Operation indicator (red)
Weight (packed state)		Approx. 270 g		Approx. 160 g		Approx. 160 g	
Material	Case	ABS					
	Lens	Methacrylic resin					
	Cover	Polycarbonate					
	Mounting Bracket	Iron					
Accessories		Mounting Bracket (with screw), nut, terminal protection cover, one set of cable connection nuts (excluding -US Models), Reflector (E39-R1: only for Retro-reflective Sensors), Instruction manual					

**Note:** The timer cannot be disabled for Models with timer functions (E3JM-□□□4T).

# Engineering Data

## Parallel Operating Range (Typical) Through-beam

E3JM-10□4(T)

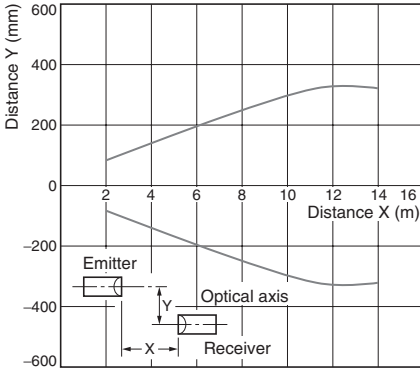

## Parallel Operating Range (Typical) Through-beam

E3JM-10□4(T) with E39-S39 (Slit)

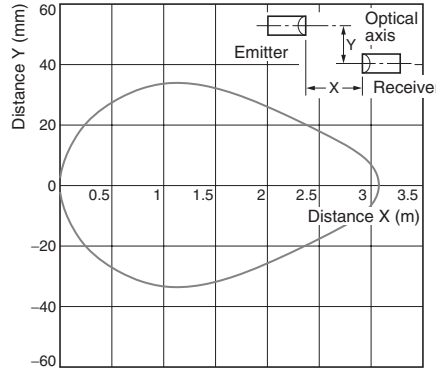

## Parallel Operating Range (Typical) Retro-reflective

E3JM-R4□4(T) (When Using E39-R1)

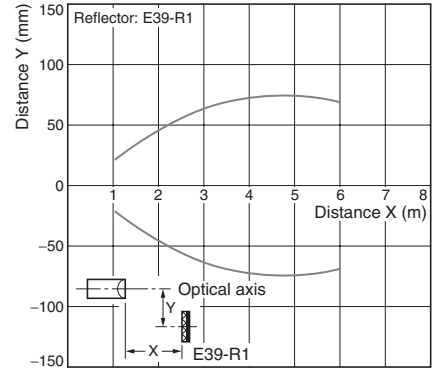

## Operating Range (Typical) Diffuse-reflective

E3JM-DS70□4(T)

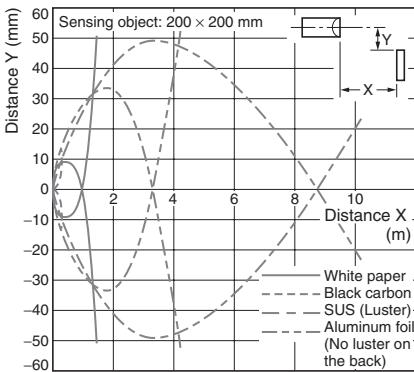

## Size of Sensing Object vs. Sensing Distance Diffuse-reflective

E3JM-DS70□4(T)

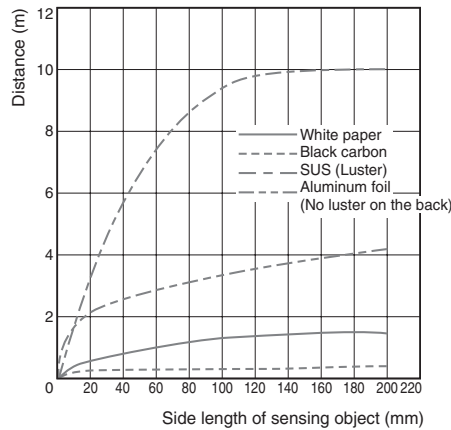

## Excess Gain Ratio vs. Set Distance (Typical) Through-beam

E3JM-10□4(T)

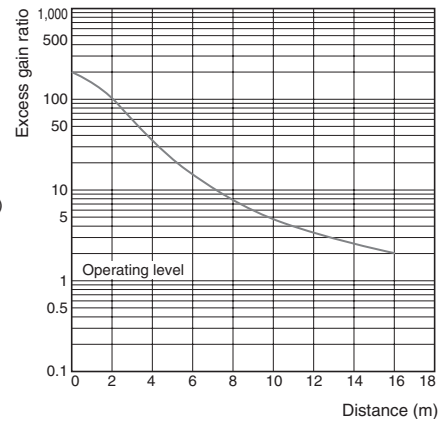

## Excess Gain Ratio vs. Set Distance (Typical) Retro-reflective

E3JM-R4□4(T) (When Using E39-R1)

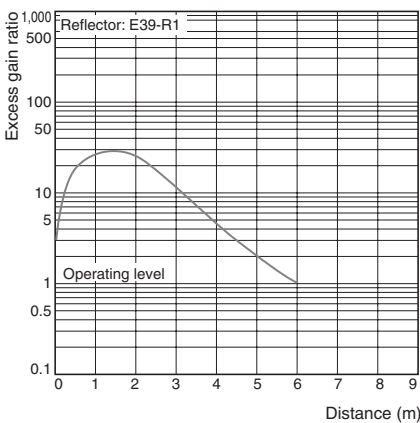

## Excess Gain Ratio vs. Set Distance (Typical) Retro-reflective

E3JM-R4□4(T) (When Using E39-R3)

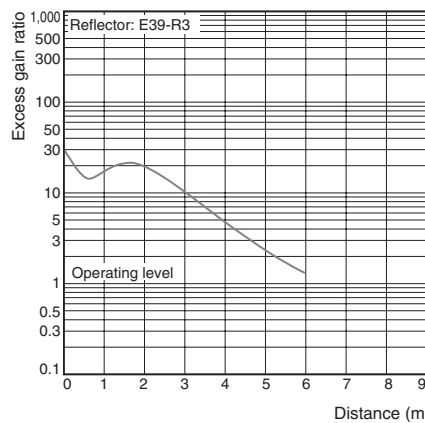

## Excess Gain Ratio vs. Set Distance (Typical) Diffuse-reflective

E3JM-DS70□4(T)

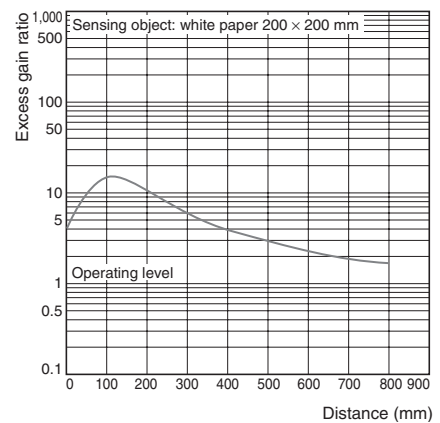

# Operation

## Output Circuit

### Relay Output Models

#### E3JM-□M4(T)

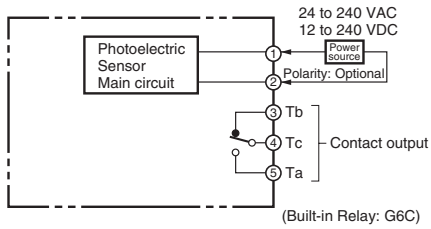

### DC SSR Output Models

#### E3JM-□S4(T)

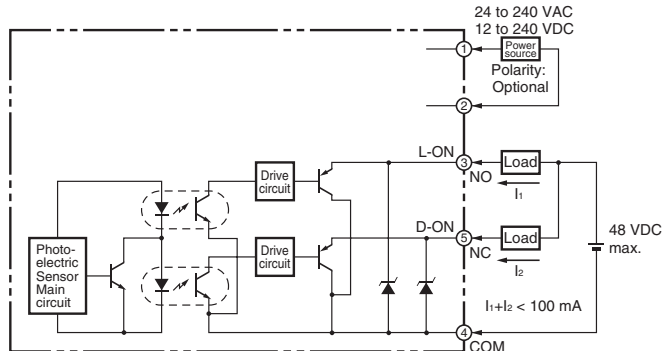

#### E3JM-□R4(T)

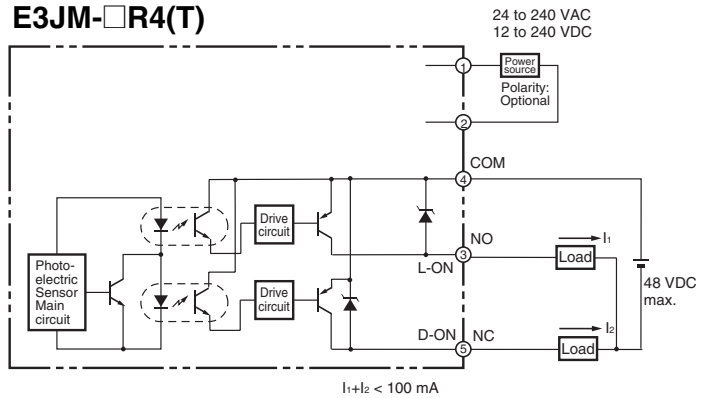

## Timing Charts

### Models without Timer

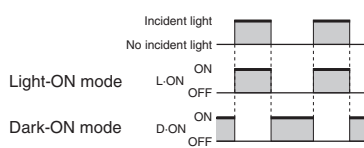

### Models with Timer

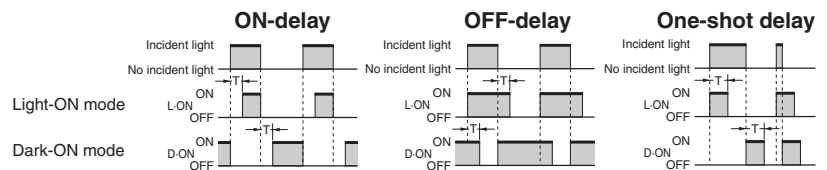

# Precautions

## WARNING

This product is not designed or rated for ensuring safety of persons. Do not use it for such purposes.

## Connections

### Through-beam Models

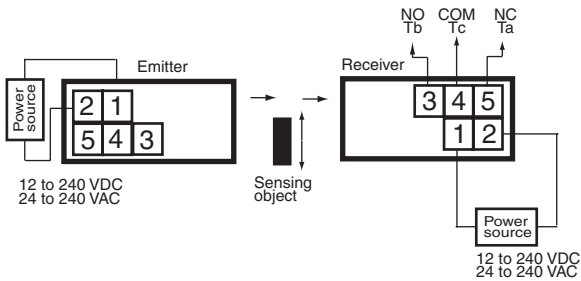

### Retro-reflective Models

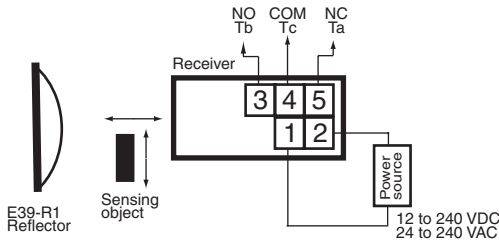

### Diffuse-reflective Models

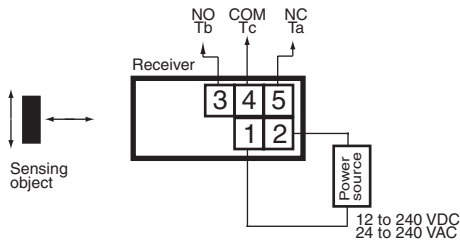

## Adjustment

### Through-beam Models

For a E3JM with the timer function, the indicator will be lit when incident light is received while the mode is switched to Light-ON, and the indicator will be lit when light is interrupted while the mode is switched to Dark-ON.

Move the Emitter and Receiver horizontally and vertically, and locate them to the center of the range in which the Receiver indicator is lit.

### Retro-reflective Models

The indicator of the Retro-reflective Model with the timer function is lit in the same way as for the Through-beam Model.

As with the Through-beam Model, adjust the Reflector and Sensor. Since the directional angle of the E3JM Retro-reflective Model is 1 to 5 degrees, pay careful attention when adjusting the Sensor.

### Diffuse-reflective Models

The indicator of the Diffuse-reflective Model with the timer function is lit in the same way as for the Through-beam Model.

Sensing object is present.

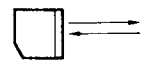

Sensing object is not present.

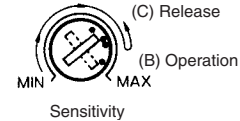
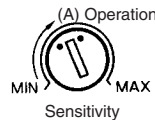

1. If a sensing object is present as shown above, turn the sensitivity adjuster clockwise to increase the sensitivity. Point (A) is where the indicator is lit.
2. Remove the sensing object and turn the adjuster clockwise. Point (B) is where the indicator is lit by background objects.
3. Turn the adjuster counterclockwise to decrease the sensitivity, starting from the point (B). Point (C) is where the indicator is lit.
4. The center point between the point (A) and point (C) is the optimum position. If the indicator is not lit by the background object at the maximum sensitivity, set to the center point between the point (A) and the maximum sensitivity.

**Note:** The sensitivity adjuster may be damaged if an excessive force is applied.

## Precautions for Correct Use

### Switch Configuration

#### Models without Timer

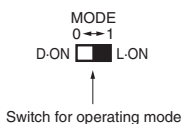

#### Models with Timer

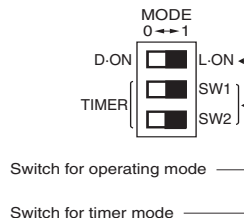

**Switch Selection**

**Models without Timer**

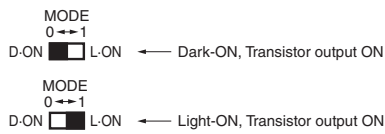

**Models with Timer**

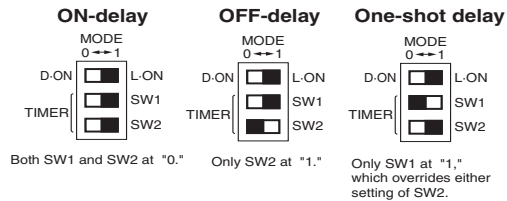

Both SW1 and SW2 at "0." Only SW2 at "1." Only SW1 at "1," which overrides either setting of SW2.  
**Note:** The switch for the operating mode is the same as that for models without a timer.

**Connecting and Wiring**

Recommended outer diameter of cables is from 6 to 8 dia.

Be sure to firmly tighten the cover in order to maintain waterproof and dustproof properties. The screw size of the conduit sockets is shown in the following table.

Model	Conduit socket thread size
E3JM-□	PF1/2

**Cable End Treatment**

Adjust the four wires to the same length when the Ta output is to be used only. If both the Ta and Tb outputs are to be used, treat them as shown in the following diagram.

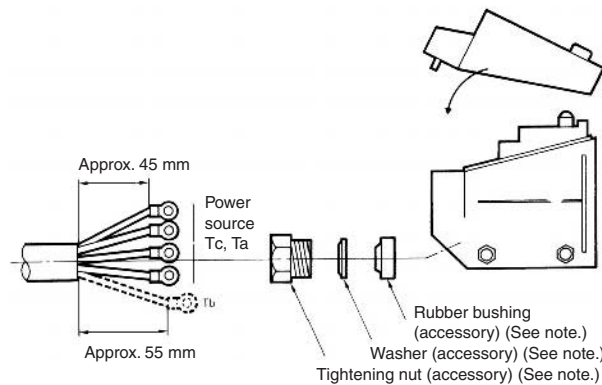

**Note:** These parts are not provided with models with a -US suffix.

**Recommended Crimp Terminal Dimensions**

(Unit: mm)

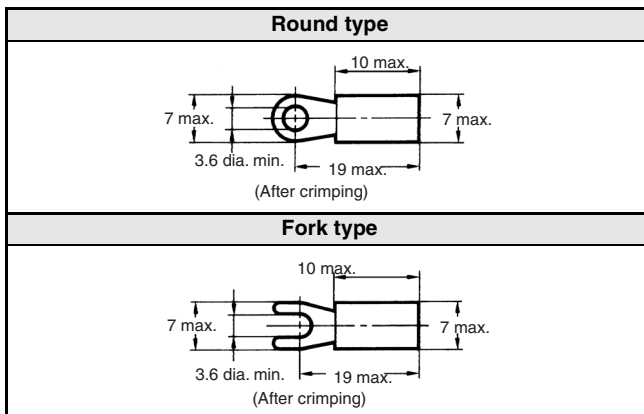

**Note:** Use terminals with insulation tube (recommended crimp terminal: 1.25 to 3.5).

**Terminal Protection Cover (Accessory)**

The terminal protection cover is designed to improve safety by maintaining the sensitivity properties of the product and by preventing any contact with charged sections while it is being operated with the mode set to the timer mode. Mount the product as shown in the following diagram (mount the Through-beam Model on the Receiver side).

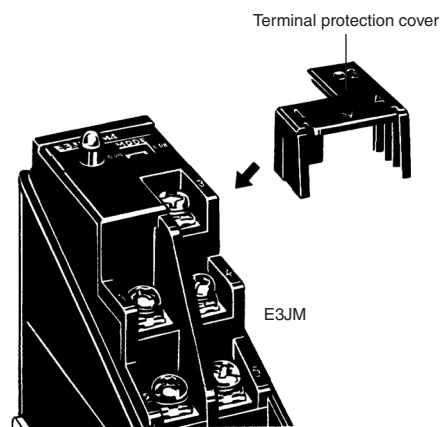

**Output Relay Contact**

If a load, such as contactor or valve is used that may produce arc when it is turned OFF, the NC (or NO) side may turn ON before the NO (or NC) side is turned OFF. When using both the NC and NO outputs, use an arc killer.

**Connecting and Wiring DC SSR Output Models**

When using the DC SSR output model, the total of the load current for the Light-ON output (NO) and that for the Dark-ON (NC) should be 100 mA max. If the total exceeds 100 mA, the load short-circuit protection function will be activated (this function will be reset when the power of the Photoelectric Sensor is turned OFF).

## Ambient Conditions (Installation Area)

The E3JM will malfunction if installed in the following places.

- Places where the E3JM is exposed to a dusty environment.
- Places where corrosive gases are produced.

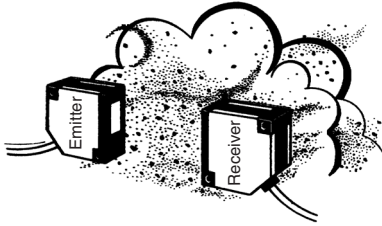

- Places where the E3JM is directly exposed to water, oil, or chemicals.

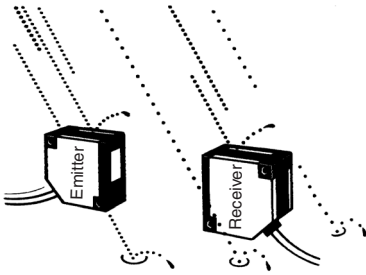

## Dimensions

**Note 1.** The operating mode switch and timer mode switch are located inside the cover.

**2.** All units are in millimeters unless otherwise indicated.

### E3JM-10□4T

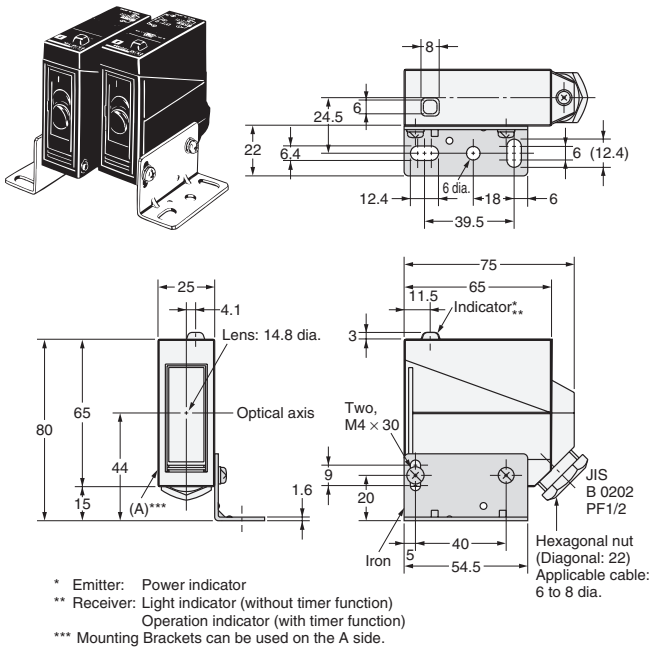

### E3JM-DS70□4(T) E3JM-R4□4(T)

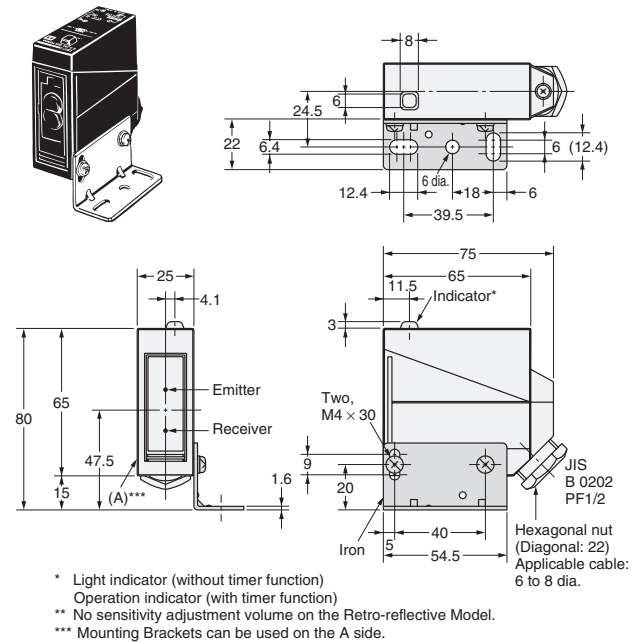



## Mounting Holes

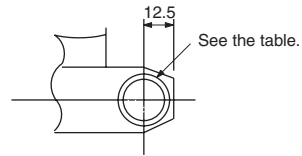
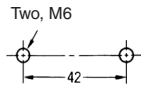

Conduit types	Suffix code
1/2-14NPT	-US
PG 13.5	-G (CENELEC conforming models)

## ■ Mounting Bracket (Order Separately)

When changing from a conventional model to an E3JM, use the E39-L51 Mounting Bracket if any optical axis deviation problems occur.

### E39-L51

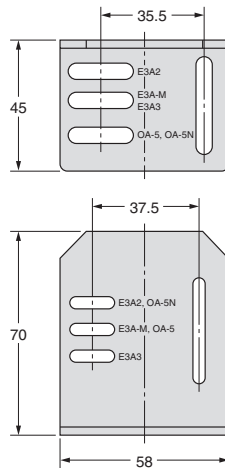
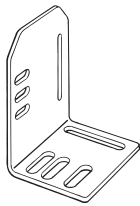

## Mounting Example

Shown below is a mounting example for changing from an E3A3 to an E3JM.

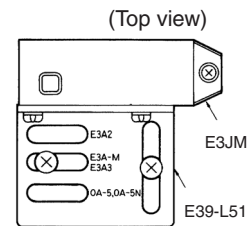

## Seal-type Long Slit E39-S39



Materials: Polyester  
0.1-mm thick

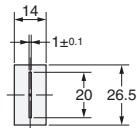

## ■ Reflectors

### E39-R1 (Provided with Retro-reflective Models)

Materials: Reflective side: PMMA (Acrylic resin)  
Back side: ABS resin

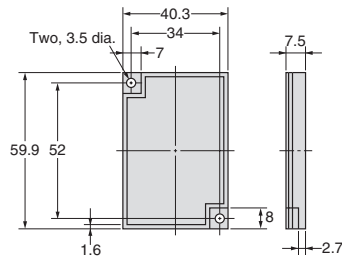

### Small Reflector (Order Separately)

#### E39-R3

Materials: Reflective side: PMMA (Acrylic resin)  
Back side: ABS resin

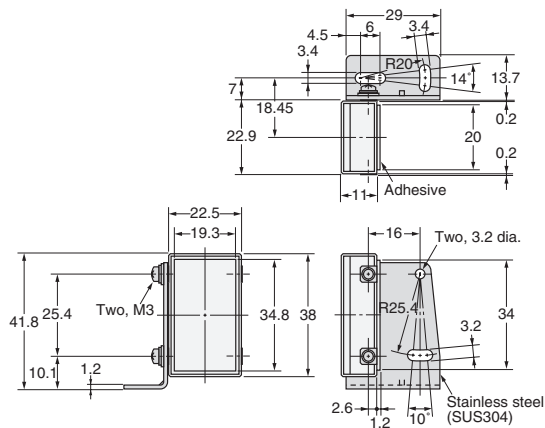
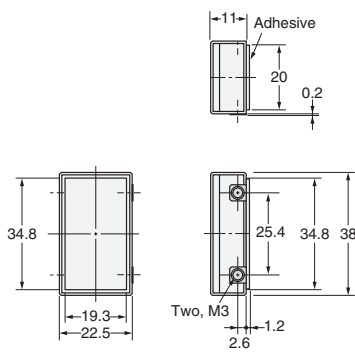

### Tape Reflectors (Order Separately)

#### E39-RS1

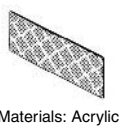

Materials: Acrylic

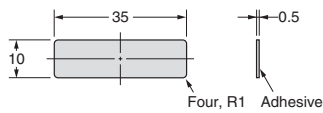

#### E39-RS2

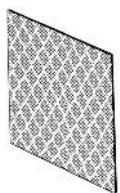

Materials: Acrylic

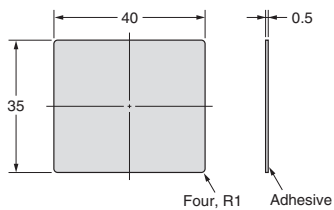

#### E39-RS3

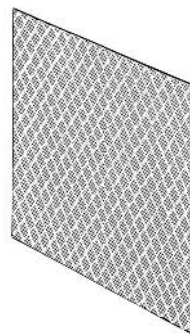

Materials: Acrylic

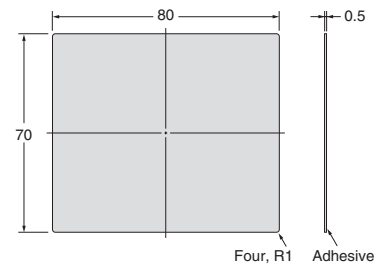



## Warranties and Limitations of Liability

---

### ■ WARRANTY

OMRON's exclusive warranty is that the products are free from defects in materials and workmanship for a period of one year (or other period if specified) from date of sale by OMRON.

OMRON MAKES NO WARRANTY OR REPRESENTATION, EXPRESS OR IMPLIED, REGARDING NON-INFRINGEMENT, MERCHANTABILITY, OR FITNESS FOR PARTICULAR PURPOSE OF THE PRODUCTS. ANY BUYER OR USER ACKNOWLEDGES THAT THE BUYER OR USER ALONE HAS DETERMINED THAT THE PRODUCTS WILL SUITABLY MEET THE REQUIREMENTS OF THEIR INTENDED USE. OMRON DISCLAIMS ALL OTHER WARRANTIES, EXPRESS OR IMPLIED.

### ■ LIMITATIONS OF LIABILITY

OMRON SHALL NOT BE RESPONSIBLE FOR SPECIAL, INDIRECT, OR CONSEQUENTIAL DAMAGES, LOSS OF PROFITS OR COMMERCIAL LOSS IN ANY WAY CONNECTED WITH THE PRODUCTS, WHETHER SUCH CLAIM IS BASED ON CONTRACT, WARRANTY, NEGLIGENCE, OR STRICT LIABILITY.

In no event shall responsibility of OMRON for any act exceed the individual price of the product on which liability is asserted.

IN NO EVENT SHALL OMRON BE RESPONSIBLE FOR WARRANTY, REPAIR, OR OTHER CLAIMS REGARDING THE PRODUCTS UNLESS OMRON'S ANALYSIS CONFIRMS THAT THE PRODUCTS WERE PROPERLY HANDLED, STORED, INSTALLED, AND MAINTAINED AND NOT SUBJECT TO CONTAMINATION, ABUSE, MISUSE, OR INAPPROPRIATE MODIFICATION OR REPAIR.

## Application Considerations

---

### ■ SUITABILITY FOR USE

THE PRODUCTS CONTAINED IN THIS CATALOG ARE NOT SAFETY RATED. THEY ARE NOT DESIGNED OR RATED FOR ENSURING SAFETY OF PERSONS, AND SHOULD NOT BE RELIED UPON AS A SAFETY COMPONENT OR PROTECTIVE DEVICE FOR SUCH PURPOSES. Please refer to separate catalogs for OMRON's safety rated products.

OMRON shall not be responsible for conformity with any standards, codes, or regulations that apply to the combination of products in the customer's application or use of the product.

Take all necessary steps to determine the suitability of the product for the systems, machines, and equipment with which it will be used.

Know and observe all prohibitions of use applicable to this product.

NEVER USE THE PRODUCT FOR AN APPLICATION INVOLVING SERIOUS RISK TO LIFE OR PROPERTY WITHOUT ENSURING THAT THE SYSTEM AS A WHOLE HAS BEEN DESIGNED TO ADDRESS THE RISKS, AND THAT THE OMRON PRODUCT IS PROPERLY RATED AND INSTALLED FOR THE INTENDED USE WITHIN THE OVERALL EQUIPMENT OR SYSTEM.

## Disclaimers

---

### ■ CHANGE IN SPECIFICATIONS

Product specifications and accessories may be changed at any time based on improvements and other reasons. Consult with your OMRON representative at any time to confirm actual specifications of purchased product.

### ■ DIMENSIONS AND WEIGHTS

Dimensions and weights are nominal and are not to be used for manufacturing purposes, even when tolerances are shown.

**ALL DIMENSIONS SHOWN ARE IN MILLIMETERS.**

To convert millimeters into inches, multiply by 0.03937. To convert grams into ounces, multiply by 0.03527.

Cat. No. E203-E1-04

**In the interest of product improvement, specifications are subject to change without notice.**

## OMRON Corporation

Industrial Automation Company

Industrial Sensors Division

Sensing Devices and Components Division H.Q.

Shiokoji Horikawa, Shimogyo-ku,

Kyoto, 600-8530 Japan

Tel: (81)75-344-7022/Fax: (81)75-344-7107

Printed in Japan

0205 (0198)-0.8C (M)